

VIDEX[®]

LED
LIGHTING



CATALOGUE 1/2024

STANDARD SHAPES WITH MATT BULBS

The combination of classic design and modern technology provides a high level of energy efficiency, leaving the quality of light consistently high.

VIDEX LED lamps are characterized by a favorable light with a laconic design and a high level of color rendering.

Thanks to a wide variety of shapes, lamps allow you to create the desired atmosphere in any room. VIDEX LED lamps can save up to 90% energy and their long lifetime makes them the ideal choice for the customer.

STANDARDOWE KSZTAŁTY Z MATOWYMI BAŃKAMI

Połączenie klasycznego wzornictwa i nowoczesnej technologii zapewnia wysoki poziom energooszczędności, pozostawiając niezmiennie wysoką jakość światła.

Źródła światła VIDEX LED charakteryzują się korzystnym światłem o lakonicznej konstrukcji i wysokim współczynnikiem oddawania barw.

Dzięki szerokiej gamie kształtów źródła światła pozwalają na stworzenie pożądanej atmosfery w każdym pomieszczeniu. Źródła światła VIDEX LED mogą zaoszczędzić do 90% energii, a ich długa żywotność sprawia, że są idealnym wyborem dla klienta.



Exclusive package is designed special for the convenient choice of the required base and color temperature. You can check the operation efficiency of the lamp without removing it from the package.

Ekskluzywne opakowanie zaprojektowane specjalnie dla wygody doboru gwintu oraz temperatury barwowej. Można sprawdzić źródło światła bez wyjmowania go z opakowania.



A60, A65

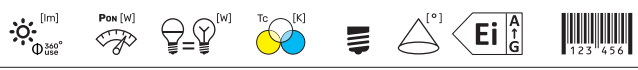

1	VLE-A60e-08273	VIDEX-E27-A60-8W-WW	760 lm	8 W	57	3000K	●	E27	240°	F	5904405540213
1	VLE-A60e-08274	VIDEX-E27-A60-8W-NW	760 lm	8 W	57	4000K	○	E27	240°	F	5904405540220
1	VLE-A60e-08276	VIDEX-E27-A60-8W-CW	760 lm	8 W	57	6000K	●	E27	240°	F	5904405540237
1	VLE-A60e-10273	VIDEX-E27-A60-10W-WW	960 lm	10 W	70	3000K	●	E27	240°	F	5904405540244
1	VLE-A60e-10274	VIDEX-E27-A60-10W-NW	960 lm	10 W	70	4000K	○	E27	240°	F	5904405540251
1	VLE-A60e-10276	VIDEX-E27-A60-10W-CW	960 lm	10 W	70	6000K	●	E27	240°	F	5904405540268
2	VLE-A60e-12273	VIDEX-E27-A60-12W-WW	1180 lm	12 W	82	3000K	●	E27	240°	F	5904405540275
2	VLE-A60e-12274	VIDEX-E27-A60-12W-NW	1180 lm	12 W	82	4000K	○	E27	240°	F	5904405540282
2	VLE-A60e-12276	VIDEX-E27-A60-12W-CW	1180 lm	12 W	82	6000K	●	E27	240°	F	5904405540299
3	VLE-A65e-15273	VIDEX-E27-A65-15W-WW	1520 lm	15 W	100	3000K	●	E27	240°	F	5904405540305
3	VLE-A65e-15274	VIDEX-E27-A65-15W-NW	1520 lm	15 W	100	4000K	○	E27	240°	F	5904405540312
3	VLE-A65e-15276	VIDEX-E27-A65-15W-CW	1520 lm	15 W	100	6000K	●	E27	240°	F	5904405540329

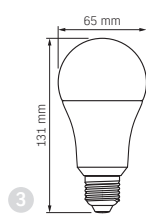
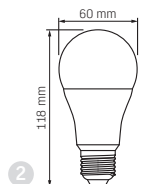
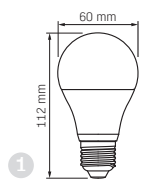

C37



1	VLE-C37e-04143	VIDEX-E14-C37-4W-WW	380 lm	4 W	33	3000K	●	E14	220°	F	5904405540336
1	VLE-C37e-04144	VIDEX-E14-C37-4W-NW	380 lm	4 W	33	4000K	○	E14	220°	F	5904405540343
2	VLE-C37e-07143	VIDEX-E14-C37-7W-WW	630 lm	7 W	50	3000K	●	E14	220°	F	5904405540350
2	VLE-C37e-07144	VIDEX-E14-C37-7W-NW	630 lm	7 W	50	4000K	○	E14	220°	F	5904405540367
3	VLE-C37e-07273	VIDEX-E27-C37-7W-WW	630 lm	7 W	50	3000K	●	E27	220°	F	5904405540374
3	VLE-C37e-07274	VIDEX-E27-C37-7W-NW	630 lm	7 W	50	4000K	○	E27	220°	F	5904405540381

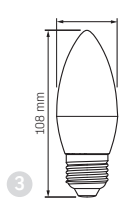
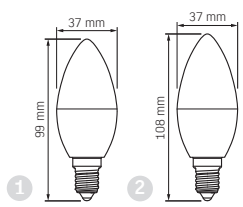



G45, G95

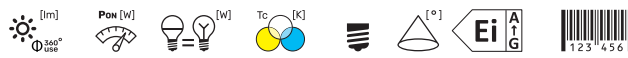

1	VLE-G45e-04143	VIDEX-E14-G45-4W-WW	380 lm	4 W	33	3000K	●	E14	240°	F	5904405540398
1	VLE-G45e-04144	VIDEX-E14-G45-4W-NW	380 lm	4 W	33	4000K	○	E14	240°	F	5904405540404
2	VLE-G45e-04273	VIDEX-E27-G45-4W-WW	380 lm	4 W	33	3000K	●	E27	240°	F	5904405540411
2	VLE-G45e-04274	VIDEX-E27-G45-4W-NW	380 lm	4 W	33	4000K	○	E27	240°	F	5904405540428
3	VLE-G45e-07143	VIDEX-E14-G45-7W-WW	630 lm	7 W	50	3000K	●	E14	240°	F	5904405540435
3	VLE-G45e-07144	VIDEX-E14-G45-7W-NW	630 lm	7 W	50	4000K	○	E14	240°	F	5904405540442
4	VLE-G45e-07273	VIDEX-E27-G45-7W-WW	630 lm	7 W	50	3000K	●	E27	240°	F	5904405540459
4	VLE-G45e-07274	VIDEX-E27-G45-7W-NW	630 lm	7 W	50	4000K	○	E27	240°	F	5904405540466
5	VLE-G95e-15273	VIDEX-E27-G95-15W-WW	1521 lm	15 W	100	3000K	●	E27	270°	F	5904405541333
5	VLE-G95e-15274	VIDEX-E27-G95-15W-NW	1521 lm	15 W	100	4000K	○	E27	270°	F	5904405541340

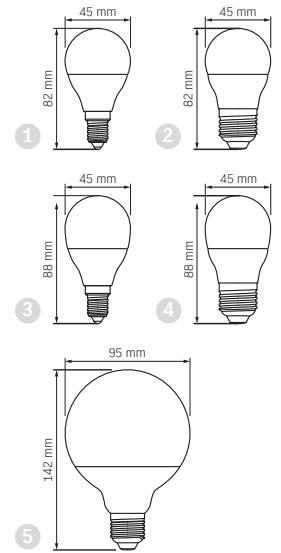

R39, R50, R63



1	VLE-R39e-04143	VIDEX-E14-R39-4W-WW	360 lm	4 W	32	3000K	●	E14	120°	F	5904405541357
1	VLE-R39e-04144	VIDEX-E14-R39-4W-NW	360 lm	4 W	32	4000K	○	E14	120°	F	5904405541364
2	VLE-R50e-06143	VIDEX-E14-R50-6W-WW	550 lm	6 W	45	3000K	●	E14	120°	F	5904405541371
2	VLE-R50e-06144	VIDEX-E14-R50-6W-NW	550 lm	6 W	45	4000K	○	E14	120°	F	5904405541388
3	VLE-R63e-09273	VIDEX-E27-R63-9W-WW	900 lm	9 W	65	3000K	●	E27	120°	F	5904405541395
3	VLE-R63e-09274	VIDEX-E27-R63-9W-NW	900 lm	9 W	65	4000K	○	E27	120°	F	5904405541401

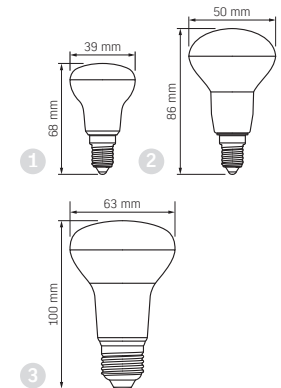



MR16

			[lm]	[W]	[W]	[K]		[°]			
1	VLE-MR16e-05103	VIDEX-GU10-5W-WW	420 lm	5 W	36	3000K	●	GU10	120°	G	5904405540480
1	VLE-MR16e-05104	VIDEX-GU10-5W-NW	420 lm	5 W	36	4000K	○	GU10	120°	G	5904405540497
1	VLE-MR16e-05106	VIDEX-GU10-5W-CW	420 lm	5 W	36	6000K	●	GU10	120°	G	5904405540503
1	VLE-MR16e-07103	VIDEX-GU10-7W-WW	600 lm	7 W	47	3000K	●	GU10	120°	F	5904405540510
1	VLE-MR16e-07104	VIDEX-GU10-7W-NW	600 lm	7 W	47	4000K	○	GU10	120°	F	5904405540527
2	VLE-MR16eL-05104	VIDEX-GU10-5W-36°-NW	400 lm	5 W	-	4000K	○	GU10	36°	F	5904405540473

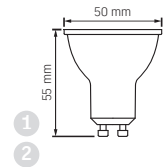

- AC 220-240V
50Hz
- IC Driver
- Ra ≥ 80
- 20 000 h
- ON/OFF
20 000
- No Flicker
- Compatible
- t°
-20 ~ +40
- 2
YEARS
Warranty

SPECIAL LENS DIFFUSER
SPECJALNY DYFUZOR SOCZEWKOWY

36°

An effective way to get spot lighting.
Dla kierunkowego oświetlenia akcentującego.



GX53

			[lm]	[W]	[W]	[K]		[°]			
	VL-GX53-08534		730 lm	8 W	55	4100K	○	GX53	140°	F	4820246484794
	VL-GX53-12534		1170 lm	12 W	80	4100K	○	GX53	140°	F	4820246484800

- AC 175-250V
50Hz
- IC Driver
- Ra ≥ 80
- 30 000 h
- ON/OFF
20 000
- No Flicker
- Compatible
- t°
-20 ~ +40
- 2
YEARS
Warranty

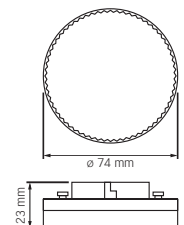

FILAMENT LAMPS NEOCLASSIC FOR BOLD DECISIONS

A new type of LED of the lamps allows achieving energy efficiency of up to 150 lumens per watt of consumed electricity.

FILAMENT LED NEOCLASSIC DO ODWAŻNYCH ROZWIĄZAŃ

Źródła światła wyposażone są w nowy rodzaj diod LED, które pozwalają na osiągnięcie energooszczędności do 150 lumenów na wat zużytej energii elektrycznej.



A60



1	VLE-A60F-10274	VIDEX-E27-A60-10W-FIL-NW	1200 lm	10 W	82	4000K ○	E27	360°	E	5904405540008
2	VLE-A60FA-10272	VIDEX-E27-A60-10W-FIL-AMBER-WW	1050 lm	10 W	74	2200K ●	E27	360°	F	5904405540015

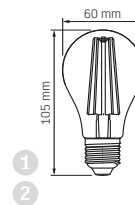

G45



1	VLE-G45F-06273	VIDEX-E27-G45-6W-FIL-WW	806 lm	6 W	60	3000K ●	E27	360°	E	5904405540077
1	VLE-G45F-06274	VIDEX-E27-G45-6W-FIL-NW	806 lm	6 W	60	4000K ○	E27	360°	E	5904405540084
2	VLE-G45FA-06272	VIDEX-E27-G45-6W-FIL-AMBER-WW	680 lm	6 W	52	2200K ●	E27	360°	E	5904405540091

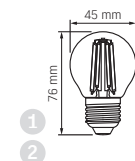



C37

			lm	P _{OH} [W]	[W]	T _c [K]		[°]	Ei	123456	
1	VLE-C35F-06143	VIDEX-E14-C35-6W-FIL-WW	806	6	60	3000K	●	E14	360°	E	5904405540107
1	VLE-C35F-06144	VIDEX-E14-C35-6W-FIL-NW	806	6	60	4000K	○	E14	360°	E	5904405540114
2	VLE-C35FI-06144	VIDEX-E14-C35-6W-FIL-FLAME-NW	806	6	60	4000K	○	E14	360°	E	5904405540121
3	VLE-C35FA-06142	VIDEX-E14-C35-6W-FIL-AMBER-WW	680	6	52	2200K	●	E14	360°	E	5904405540138
4	VLE-C35FA-06142	VIDEX-E14-C35-6W-FIL-FLAME-AMBER-WW	680	6	52	2200K	●	E14	360°	E	5904405540145

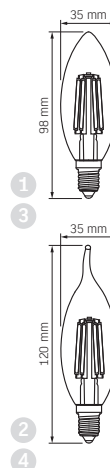

ST64



			lm	P _{OH} [W]	[W]	T _c [K]		[°]	Ei	123456	
1	VLE-ST64FD-06274	VIDEX-E27-ST64-6W-FIL-DIM-NW	630	6	50	4000K	○	E27	360°	F	5904405540039
2	VLE-ST64FAD-06272	VIDEX-E27-ST64-6W-FIL-DIM-AMBER-WW	550	6	44	2200K	●	E27	360°	F	5904405540046
3	VLE-ST64FGD-04271	VIDEX-E27-ST64-4W-FIL-DIM-SPIRAL-GRAPHITE-WW	100	4	-	1800K	●	E27	360°	-	5904405540060
4	VLE-ST64FASD-04272	VIDEX-E27-ST64-4W-FIL-DIM-SPIRAL-AMBER-WW	300	4	28	2200K	●	E27	360°	G	5904405540053

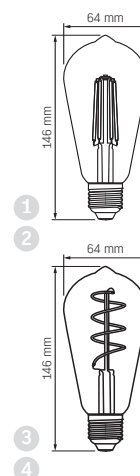



G95

1	VLE-G95FD-07274	VIDEX-E27-G95-7W-FIL-DIM-NW	806 lm	7 W	60	4000K ○	E27	360°	E	5904405540152
2	VLE-G95FAD-07272	VIDEX-E27-G95-7W-FIL-DIM-AMBER-WW	700 lm	7 W	53	2200K ●	E27	360°	F	5904405540169
3	VLE-G95FGD-04271	VIDEX-E27-G95-4W-FIL-DIM-SPIRAL-GRAPHITE-WW	100 lm	4 W	–	1800K ●	E27	360°	–	5904405540183
4	VLE-G95FASD-04272	VIDEX-E27-G95-4W-FIL-DIM-SPIRAL-AMBER-WW	300 lm	4 W	28	2200K ●	E27	360°	G	5904405540176

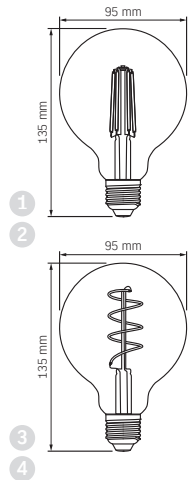

G200, PS160

1	VLE-G200FASD-08271	VIDEX-E27-G200-8W-FIL-DIM-SPIRAL-AMBER-WW1	500 lm	8 W	42	2200K ●	E27	360°	–	5904405542330
2	VLE-PS160FASD-08271	VIDEX-E27-PS160-8W-FIL-DIM-SPIRAL-AMBER-WW1	500 lm	8 W	42	2200K ●	E27	360°	–	5904405542323

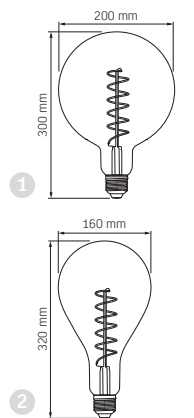

PROFESSIONAL LED LIGHTING

Maximum reliability, ergonomics and productivity with high power lamps VIDEX. Provide high efficiency and ideal light distribution for any room.

PROFESJONALNE OŚWIETLENIE LED

Maksymalna niezawodność, ergonomia i wydajność dzięki źródłom światła VIDEX o dużej mocy. Zapewniają wysoką wydajność i idealny rozsył światła w każdym pomieszczeniu.



A96, A108

1	VLE-A96-30274	VIDEX-E27-A96-30W-NW	3200 Lm	30 W	4000K ○	E27	330°	F	5904405540190
2	VLE-A108-50274	VIDEX-E27-A108-50W-NW	5400 Lm	50 W	4000K ○	E27	330°	F	5904405540206

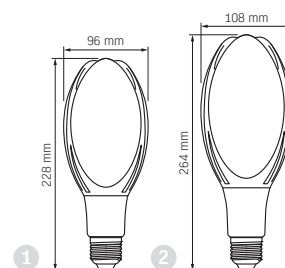

T8

	CONNECTION								
1	unilateral	VIDEX-T8-LED-60-10W-NW	1050 Lm	10 W	4000K ○	G13	330°	F	5904405540664
1	unilateral	VIDEX-T8-LED-60-10W-CW	1050 Lm	10 W	6000K ●	G13	330°	F	5904405540671
2	unilateral	VIDEX-T8-LED-120-18W-NW	2000 Lm	18 W	4000K ○	G13	330°	E	5904405540688
2	unilateral	VIDEX-T8-LED-120-18W-CW	2000 Lm	18 W	6000K ●	G13	330°	E	5904405540695
3	double-sided	VIDEX-T8-LED-150-24W-NW	2700 Lm	24 W	4000K ○	G13	330°	E	5904405540701
3	double-sided	VIDEX-T8-LED-150-24W-CW	2700 Lm	24 W	6000K ●	G13	330°	E	5904405540718

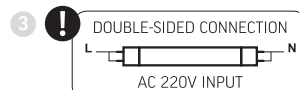
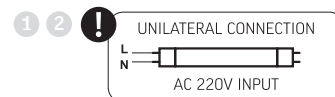
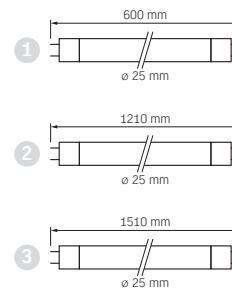

No glue is used to fix the LEDs inside the lamp to block heat dissipation. This solution significantly extends the lamp lifetime and reduces the loss of luminous flux.

Do mocowania diod LED wewnątrz źródła światła nie stosujemy kleju, który blokuje rozpraszanie ciepła. Takie rozwiązanie znacznie wydłuża żywotność źródła światła i zmniejsza straty strumienia świetlnego.

VIDEX

PLANT GROW LAMPS

Plan growing lamps intended for stimulating and accelerating the growth of house plants. Lamps of this type emit light in the blue and red spectrum, which is mostly needed by plants for growth and development. Such light can partially replace natural sunlight. Particularly appropriate will be the use of phytolamps in the season with short light days, when you need to compensate for the deficiency of sunlight.

Zaplanuj lampy uprawne przeznaczone do stymulowania i przyspieszania wzrostu roślin domowych. Lampy tego typu emitują światło w niebieskim i czerwonym spektrum, które są najczęściej potrzebne roślinom do wzrostu i rozwoju. Takie światło może częściowo zastąpić naturalne światło słoneczne. Szczególnie odpowiednie będzie użycie fitoolamp w sezonie z krótkimi dniami świetlnymi, kiedy trzeba zrekomensować niedobór światła słonecznego.



LED PLANT GROW LIGHT IS THE IDEAL CHOICE FOR STIMULATING THE GROWTH AND FURTHER DEVELOPMENT OF THE PLANTS

The universal solution for the most favorable conditions:

- for growing seedlings
- for lighting ornamental plants
- to illuminate plants in winter or in conditions of insufficient natural light

OŚWIETLENIE LED DO UPRAWY ROŚLIN TO IDEALNY WYBÓR DO STYMULACJI WZROSTU I DALSZEGO ROZWOJU ROŚLIN

Uniwersalne rozwiązanie, które daje najkorzystniejsze warunki:

- do uprawy sadzonek
- do oświetlania roślin ozdobnych
- do oświetlania roślin zimą lub w warunkach niedostatecznego oświetlenia naturalnego

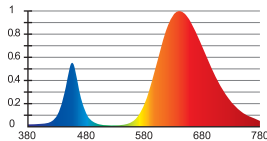

The use of different light spectrum's LEDs supports the needs of all types of plants.

Blue spectrum – affects the development of the root system.
Red spectrum – stimulates the processes of photosynthesis and reproduction of plants.



A60, R80

PPF

1	VLE-A60FF-08271	VIDEX-E27-A60-8W-FITO	14 μmol/s	8 W	–	1200K	●	E27	360°	–	5904405540022
2	VLE-R80FF-09271	VIDEX-E27-R80-9W-FITO	14 μmol/s	9 W	–	1200K	●	E27	120°	–	5904405542415

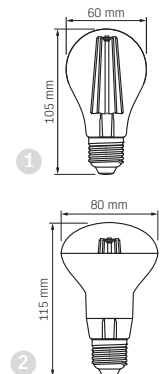

VIDEX

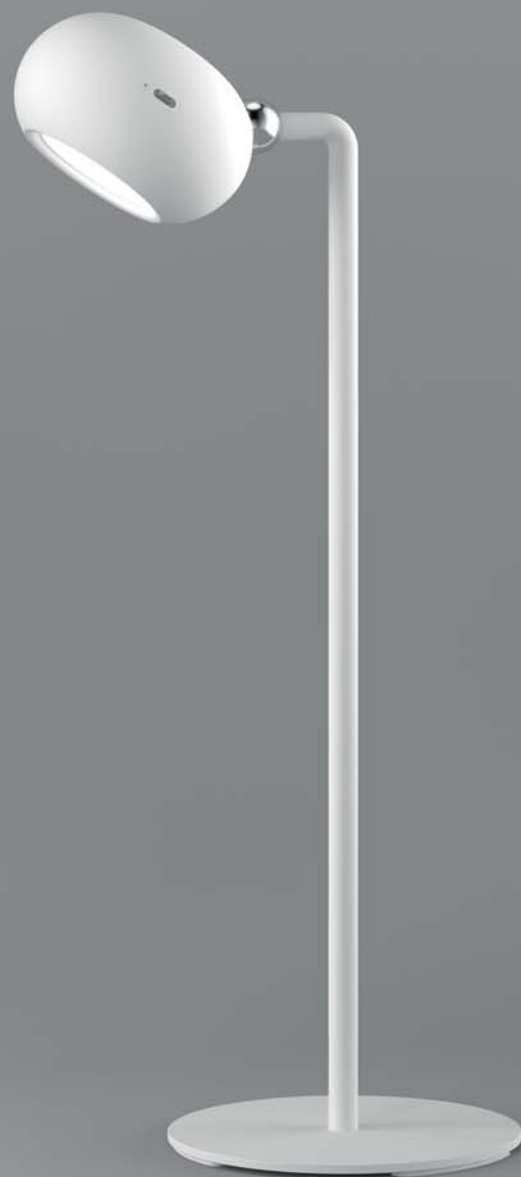

DESK & FLOOR LAMPS

The role of lighting in the interior is very important. Properly planned lighting gives the interior a perfection. Different rooms also need a different approach to the choice of light. One of the best solutions for creating a home atmosphere are desk lamps and floor lamps. VIDEX products help you make a choice in favor of quality and functionality. Thanks to their laconic and stylish design, they can be harmoniously combined with any interior.

Rola oświetlenia we wnętrzu jest bardzo ważna. Odpowiednio zaplanowane oświetlenie nadaje wnętrzu perfekcji. Różne pomieszczenia wymagają też innego podejścia do doboru światła. Jednym z najlepszych rozwiązań na stworzenie domowej atmosfery są lampy biurkowe i podłogowe. Produkty VIDEX pomagają dokonać wyboru na rzecz jakości i funkcjonalności. Dzięki lakonicznemu i stylowemu wzornictwu harmonijnie komponują się z każdym wnętrzem.





DESK LAMP

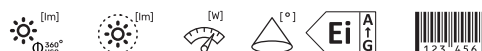

VLE-TF15R ●	VIDEX-DESK-LAMP-LISBON-RED	1450 lm	900 lm	17 W	120°	F	5904405541579
VLE-TF15B ●	VIDEX-DESK-LAMP-LISBON-BLACK	1450 lm	900 lm	17 W	120°	F	5904405541319
VLE-TF15W ○	VIDEX-DESK-LAMP-LISBON-WHITE	1450 lm	900 lm	17 W	120°	F	5904405541326



LED desk lamp with double control, gestures or touch buttons. High color rendering index and protection against glare provide maximum eye protection.

Lampa biurkowa LED z podwójnym sterowaniem, gestami lub przyciskami dotykowymi. Wysoki współczynnik oddawania barw i ochrona przed odbłaskami zapewniają maksymalną ochronę oczu.

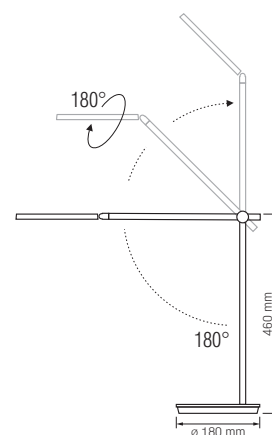

DESK LAMP

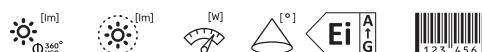

VLE-TF02W	VIDEX-DESK-LAMP-OSLO	490 lm	280 lm	5 W	120°	F	5904405541227
-----------	----------------------	--------	--------	-----	------	---	---------------

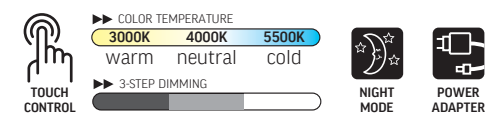

For using the lamp as a night light is enough to switch warm light mode and fold it down.

Aby wykorzystać lampę jako lampkę nocną wystarczy przełączyć ją na tryb ciepłego światła i złożyć.

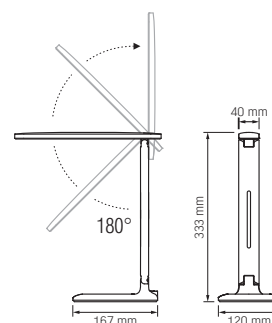

DESK LAMP

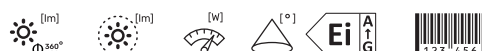

VLE-TF03W	VIDEX-DESK-LAMP-DENVER	370 lm	240 lm	5.5 W	120°	G	5904405541296
-----------	------------------------	--------	--------	-------	------	---	---------------

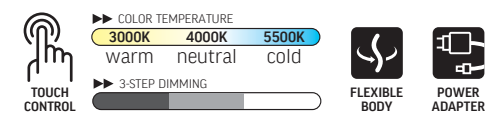

Flexible body of lamp allows to set the desired direction of light.

Elastyczny korpus lampy pozwala ustawić żądany kierunek padania światła.

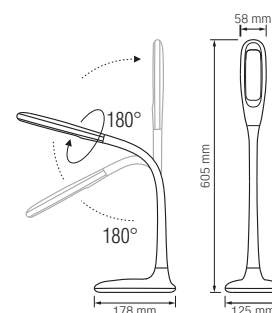



DESK LAMP

VLE-TF05W ○	VIDEX-DESK-LAMP-RIO	490 lm	280 lm	5 W	120°	F	5904405541234
VLE-TF05B ●	VIDEX-DESK-LAMP-RIO	490 lm	280 lm	5 W	120°	F	5904405541272

TOUCH CONTROL
 ▶ COLOR TEMPERATURE
 3000K warm 4000K neutral 5500K cold
 ▶ 5-STEP DIMMING
 LCD DISPLAY
 POWER ADAPTER

Additional functions: clock, alarm clock, calendar, thermometer. The LCD display can be turned off if necessary.

Dodatkowe funkcje: zegar, budzik, kalendarz, termometr. Wyświetlacz LCD można w razie potrzeby wyłączyć.

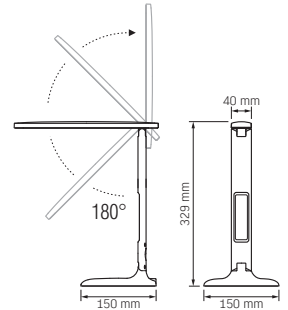

AC 100-240V 50Hz
 Ra ≥ 80
 30 000 h
 ON/OFF 20 000
 No Flicker
 t°C -10 ~ +40
 2 YEARS Warranty



DESK LAMP

VLE-TF05W-RGB	VIDEX-DESK-LAMP-NAIROBI	490 lm	300 lm	7.5 W	120°	F	5904405541289
---------------	-------------------------	--------	--------	-------	------	---	---------------

TOUCH CONTROL
 ▶ COLOR TEMPERATURE
 3000K warm 4000K neutral 5500K cold
 ▶ 5-STEP DIMMING
 LCD DISPLAY
 POWER ADAPTER

Additional functions: clock, alarm clock, calendar, thermometer. The LCD display can be turned off if necessary.

Dodatkowe funkcje: zegar, budzik, kalendarz, termometr. Wyświetlacz LCD można w razie potrzeby wyłączyć.

A wide range of different colors allows you to create the mood in any interior.

Szeroka gama różnych kolorów pozwala na stworzenie nastroju w każdym wnętrzu.

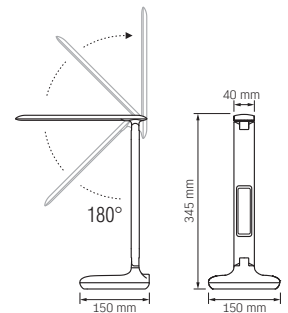

AC 100-240V 50Hz
 Ra ≥ 80
 30 000 h
 ON/OFF 20 000
 No Flicker
 t°C -10 ~ +40
 2 YEARS Warranty



DESK LAMP

VLE-TF09W	VIDEX-DESK-LAMP-HELSINKI	370 lm	280 lm	6 W	120°	G	5904405541302
-----------	--------------------------	--------	--------	-----	------	---	---------------

TOUCH CONTROL
 ▶ COLOR TEMPERATURE
 3000K warm 4000K neutral 5500K cold
 ▶ NON-STEP DIMMING
 FLEXIBLE BODY
 CLIP BASE
 POWER ADAPTER

Convenient construction and flexible body of lamp allow to set the optimal position. Smooth adjustment makes it easy to select the desired brightness mode.

Wygodna konstrukcja i elastyczny korpus lampy pozwalają na ustawienie optymalnej pozycji. Płynna regulacja ułatwia wybór żądanego trybu jasności.

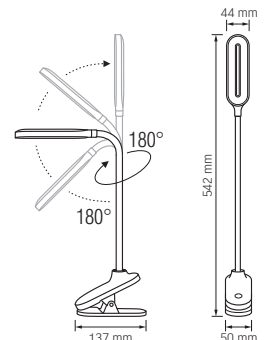

AC 100-240V 50Hz
 Ra ≥ 80
 30 000 h
 ON/OFF 20 000
 No Flicker
 t°C -10 ~ +40
 2 YEARS Warranty

DESK LAMP



VLE-TF11W	VIDEX-DESK-LAMP-BERLIN	100 lm	5 W	120°	-	5904405541210
-----------	------------------------	--------	-----	------	---	---------------



► COLOR TEMPERATURE
3000K 4000K 5500K
 warm neutral cold
 ► 3-STEP DIMMING



AT ONE CHARGE



USB-C CABLE

The desk lamp has the built-in rechargeable battery (1800 mAh) and can be used without connection to a household power supply.

The desk lamp can be used as flashlight.

Lampa biurkowa ma wbudowany akumulator (1800 mAh) i może być używana bez podłączenia do źródła zasilania.

Lampa biurkowa może służyć jako latarka.

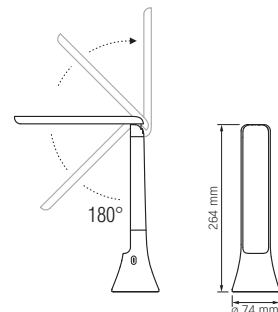

DC 5V 1A



Ra ≥ 80



30 000 h



20 000



No Flicker



-10 ~ +40



2 YEARS Warranty

DESK LAMP



VL-TF12W		700 lm	500 lm	12 W	120°	F	4820118299587
----------	--	--------	--------	------	------	---	---------------



► COLOR TEMPERATURE
3000K 4000K 4500K 5000K 6500K
 warm neutral cold
 ► NON-STEP DIMMING



NIGHT MODE



POWER ADAPTER

A multifunctional lamp with a convenient brightness adjustment panel and a separate night light. Additional USB-A output to charge mobile devices.

Wielofunkcyjna lampa z wygodnym panelem regulacji jasności i oddzielnym nocnym światłem. Dodatkowe wyjście USB-A do ładowania urządzeń mobilnych.

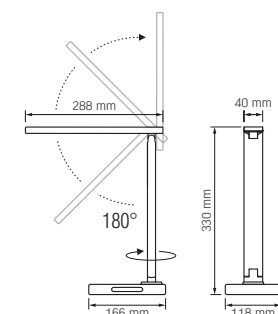

AC 100-240V 50Hz



Ra ≥ 80



30 000 h



20 000



No Flicker



-10 ~ +40



2 YEARS Warranty

DESK LAMP



VL-TF14W		1700 lm	1000 lm	20 W	120°	F	4820246480642
----------	--	---------	---------	------	------	---	---------------



► COLOR TEMPERATURE
4100K
 neutral
 ► NON-STEP DIMMING



FLEXIBLE BODY



POWER ADAPTER

Maximum accurate color rendering of illuminated objects thanks to new generation LEDs. A specially designed light diffuser protects the eyes from overload.

Maksymalnie dokładne oddawanie barw oświetlanych obiektów dzięki diodom LED nowej generacji. Specjalnie zaprojektowany dyfuzor światła chroni oczy przed przeciążeniem.

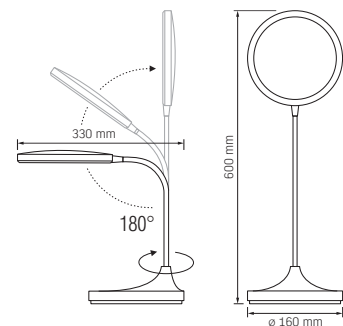

AC 100-240V 50Hz



Ra ≥ 98



40 000 h



20 000



No Flicker



-10 ~ +40



3 YEARS Warranty



DESK LAMP

VL-TF16W

250 lm 5 W 120° - 4820246484039



COLOR TEMPERATURE
 3000K 4000K 5000K
 warm neutral cold
 3-STEP DIMMING

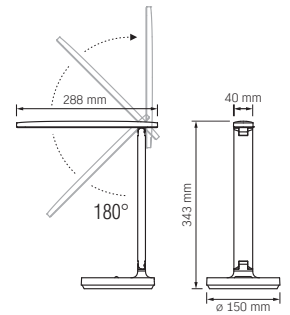

The rechargeable table lamp can work up to 24 hours without recharging and has a convenient night light. With touch buttons, you can smoothly or gradually change the brightness, color, turn on a separate night light.

Ładowana lampa stołowa może pracować do 24 godzin bez ładowania i posiada wygodną lampkę nocną. Za pomocą przycisków dotykowych można płynnie lub stopniowo zmieniać jasność, kolor, włączając osobne światło nocne.



DC 5V 1A

Ra ≥ 80

30 000 h

20 000

No Flicker

-10 ~ +40

Warranty



DESK LAMP

VL-TF17B

700 lm 500 lm 18 W 120° F 4820246484046



COLOR TEMPERATURE
 1800K 3000K 3800K 4500K 5000K 6500K
 warm neutral cold
 5-STEP DIMMING

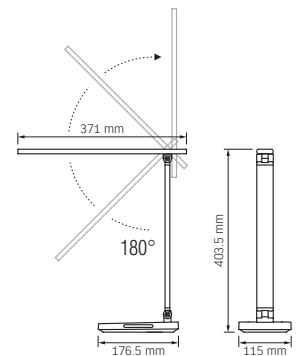

Aluminum lamp with wireless charging with a comfortable night light. Additional USB-A output for powering mobile devices.

Aluminiowa lampa z bezprzewodowym ładowaniem z wygodną lampką nocną. Dodatkowe wyjście USB-A do zasilania urządzeń mobilnych.



AC 100-240V 50Hz

Ra ≥ 80

40 000 h

20 000

No Flicker

-10 ~ +40

Warranty



DESK LAMP

VLE-TF18W ○

300 lm 5 W 120° - 5904405542545

VLE-TF18B ●

300 lm 5 W 120° - 5904405542552



COLOR TEMPERATURE
 3000K 4000K 5500K
 warm neutral cold
 NON-STEP DIMMING

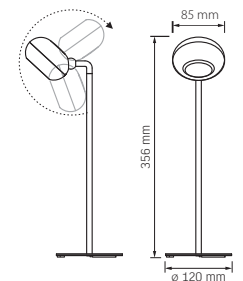

Versatile LED lamp with magnetic attachment on the hinge. The kit includes three different mounts (desk base, clip, adhesive surface mounting base). The built-in battery provides up to 2000 full charge cycles.

Wszechstronna lampa LED z mocowaniem magnetycznym na zawieszce. W zestawie znajdują się trzy różne uchwyty (podstawa na biurko, klips, samoprzylepna podstawa do montażu powierzchniowego). Wbudowany akumulator zapewnia do 2000 pełnych cykli ładowania.



DC 5V 2A

Ra ≥ 80

30 000 h

20 000

No Flicker

-10 ~ +40

Warranty

FLOOR LAMP



VLE-TF07W ○	VIDEX-FLOOR-LAMP-TOKYO-WHITE	1280 lm	700 lm	12 W	120°	F	5904405541258
VLE-TF07B ●	VIDEX-FLOOR-LAMP-TOKYO-BLACK	1280 lm	700 lm	12 W	120°	F	5904405541241

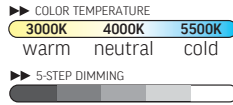

With the folding parts of the lamp, it can be used as a floor lamp or as a desk lamp. The flexible body of desk lamp allows to set the desired direction of light.

Dzięki składanym częściom lampy może być ona używana jako lampa podłogowa lub jako lampa biurkowa. Elastyczny korpus lampy pozwala ustawić żądany kierunek padania światła.

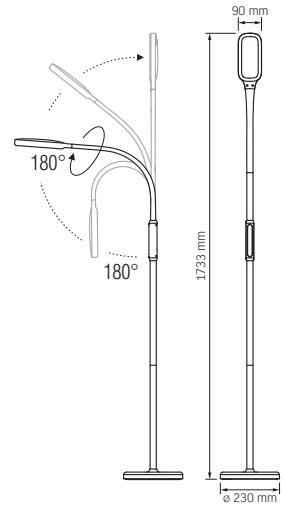

AMBIENT FLOOR LIGHT



VL-TF20-RGB ○		250 lm	10 W	360°	-		4820246485463
---------------	--	--------	------	------	---	--	---------------

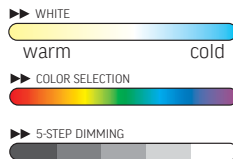

LED ambient floor lamp, easy to assemble by yourself. With 16 million of shades, it can sync with music. Many presets with remote control.

Nastrojowa lampa podłogowa LED, łatwa w samodzielnym montażu. Dzięki 16 milionom odcieni może synchronizować się z muzyką. Wiele ustawień wstępnych z pilotem.

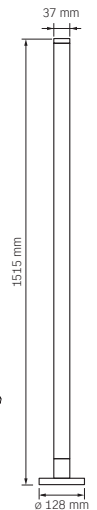
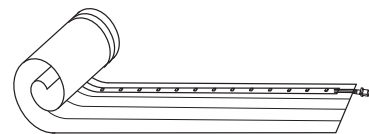

- **WARM WHITE / COLD WHITE.** Imitation of shades of white light.
- **BRIGHTNESS ADJUST.** Adjusting the brightness of any of the selected colors and modes.
- **MUSIC MODE.** Synchronization with surrounding sounds using an acoustic sensor.
- **COLOR PRESETS.** Set single color or chose one of the preset color combinations.
- **DYNAMIC MODES.** Programmed alternation of pre-selected colors.
- **TIMERS.** Automatic light shutdown after 4 or 8 hours.

- **CIĘPLY BIAŁY / ZIMNY BIAŁY.** Imitacja odcieni białego światła.
- **REGULACJA JASNOŚCI.** Regulacja jasności dowolnego z wybranych kolorów i trybów.
- **TRYB MUZYCZNY.** Synchronizacja z dźwiękami otoczenia za pomocą czujnika akustycznego.
- **WSTĘPNE USTAWIENIA KOLORÓW.** Ustaw pojedynczy kolor lub wybierz jedną z gotowych kombinacji kolorów.
- **TRYBY DYNAMICZNE.** Zaprogramowana zmiana wcześniej wybranych kolorów.
- **TIMERY.** Automatyczne wyłączenie światła po 4 lub 8 godzinach.



VIDEX

SLIM MAGNETIC TRACKLIGHT

New generation magnetic low-voltage 48 V track lighting systems have a slim appearance, safety in use, convenient and simple installation, which ideally suit modern interior layout and meet aesthetic requirements of demanded users.

All lights are equipped with innovative diodes with a high color rendering index $Ra > 90$, which ensure accurate reproduction of original interior colors.

Magnetyczne systemy oświetlenia szynowego niskiego napięcia 48 V nowej generacji charakteryzują się smukłym wyglądem, bezpieczeństwem użytkowania, wygodnym i prostym montażem, dzięki czemu idealnie komponują się z nowoczesnym układem wnętrza i spełniają wymagania estetyczne wymagających użytkowników.

Wszystkie lampy wyposażone są w innowacyjne diody o wysokim współczynniku oddawania barw $Ra > 90$, które zapewniają wierne odwzorowanie naturalnych barw wnętrza.



GRIDLIGHT



1	VL-TRMS-LD13B	420 lm	5.5 W	4000K	○	90°	G	4820246485739
2	VL-TRMS-LD16B	880 lm	11 W	4000K	○	90°	F	4820246485746
3	VL-TRMS-LD19B	1400 lm	18 W	4000K	○	90°	G	4820246485753

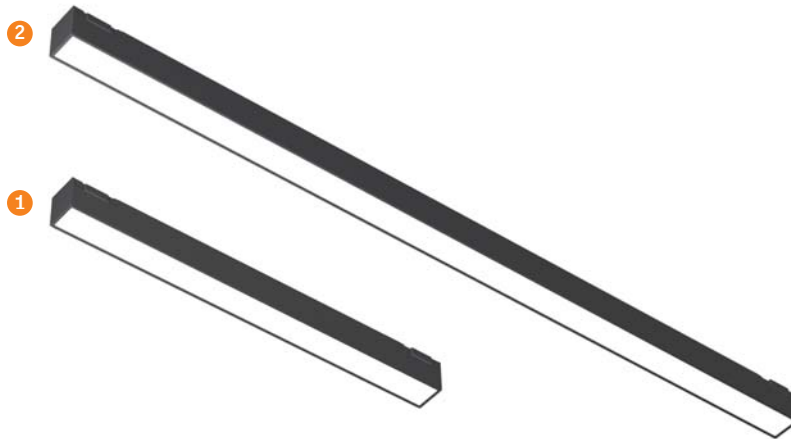
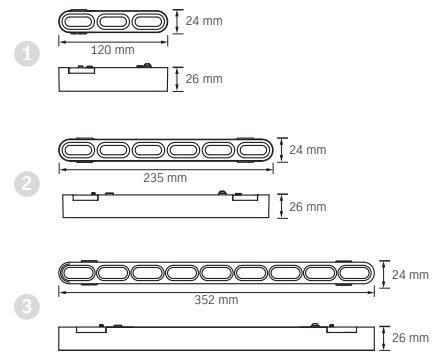

FLOOD LIGHT



1	VL-TRMS-LD430B	980 lm	10.5 W	4000K	○	110°	F	4820246485760
2	VL-TRMS-LD460B	1950 lm	21 W	4000K	○	110°	F	4820246485777

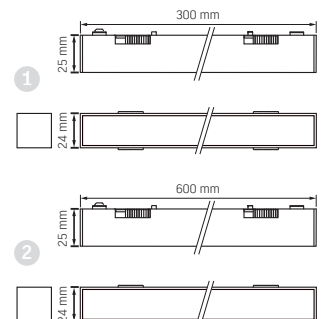



SPOT LIGHT

	[lm]	PON [W]	Tc [K]	[°]	Ei	123 456
1 VL-TRMS-LA76B	720 lm	8.5 W	4000K	36°	F	4820246485715
2 VL-TRMS-LA78B	1700 lm	18 W	4000K	36°	F	4820246485722

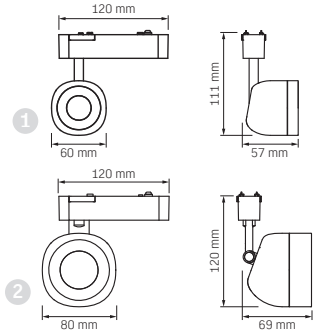

- DC 48 V
- Ra ≥ 90
- 30 000 h
- ON/OFF 20 000
- No Flicker
- IP20
- House
- t° -20 ~ +45
- 3 YEARS Warranty



GRIDLIGHT

	[lm]	PON [W]	Tc [K]	[°]	Ei	123 456
1 VL-TRMS-LE24B	610 lm	7.5 W	4000K	36°	F	4820246485784
2 VL-TRMS-LE29B	1380 lm	16 W	4000K	36°	F	4820246485791

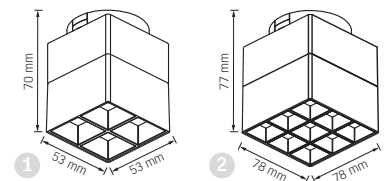

- DC 48 V
- Ra ≥ 90
- 30 000 h
- ON/OFF 20 000
- No Flicker
- IP20
- House
- t° -20 ~ +45
- 3 YEARS Warranty



POWER SUPPLY

	PON [W]	[V]	Tc [K]	123 456
VL-TRMS-P100B	100 W	DC 48 V	1 A	4820246485807
VL-TRMS-P200B	200 W	DC 48 V	1 A	4820246485814

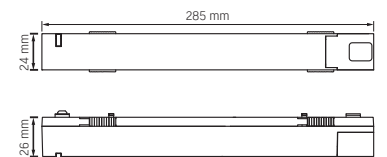

- AC 220-240V 50Hz
- 30 000 h
- ON/OFF 20 000
- IP20
- House
- t° -20 ~ +45
- 3 YEARS Warranty

Nickel plated contacts
Niklowane styki



6,5 mm

ACCESSORIES / AKCESORIA

1m

Surface busbar.
Szlina powierzchniowa.
1000x24x6.5 mm



VL-TRMS-FTS10B ● 4820246485692

2m

Surface busbar.
Szlina powierzchniowa.
2000x24x6.5 mm



VL-TRMS-FTS20B ● 4820246485708

2m

Recessed busbar.
Szlina wpuszczana.
2000x24x6.5 mm



VL-TRMS-FTR20B ● 4820246485685

Straight connector.
Złącze równe.
33x24x6.5 mm



VL-TRMS-FC01B ● 4820246485609

T-connector.
Złącze w kształcie litery T.
46x35x6.5 mm



VL-TRMS-FC02B ● 4820246485616

Vertical connector.
Złącze pionowe.
30x30x24 mm



VL-TRMS-FC03B ● 4820246485623

Horizontal adjustable connector.
Pozioame regulowane złącze.
68x24x9.5 mm



VL-TRMS-FC04B ● 4820246485630

Cross connector.
Złącze krzyżowe.
46x46x6.5 mm



VL-TRMS-FC05B ● 4820246485647

Input connector box.
Skrzynka złączy wejściowych.
46x24x18 mm



VL-TRMS-FC06B ● 4820246485654

Splicer after cutting.
Splicer po cięciu.
46x24x18 mm



VL-TRMS-FC07B ● 4820246485661

Power conversion box.
Skrzynka konwersji mocy.
48.5x25.5x19.5 mm
L: 30 cm



VL-TRMS-FC08B ● 4820246485678



TRACK LIGHT



1	VLE-TR04-104W	○	VIDEX-TOR-10W-WHITE	800 lm	10 W	4000K	○	36°	F	5904405541449
2	VLE-TR04-104B	●	VIDEX-TOR-10W-BLACK	800 lm	10 W	4000K	○	36°	F	5904405541432
3	VLE-TR04-204W	○	VIDEX-TOR-20W-WHITE	1600 lm	20 W	4000K	○	36°	F	5904405541463
4	VLE-TR04-204B	●	VIDEX-TOR-20W-BLACK	1600 lm	20 W	4000K	○	36°	F	5904405541456
5	VLE-TR04-304W	○	VIDEX-TOR-30W-WHITE	2400 lm	30 W	4000K	○	36°	F	5904405541487
6	VLE-TR04-304B	●	VIDEX-TOR-30W-BLACK	2400 lm	30 W	4000K	○	36°	F	5904405541470

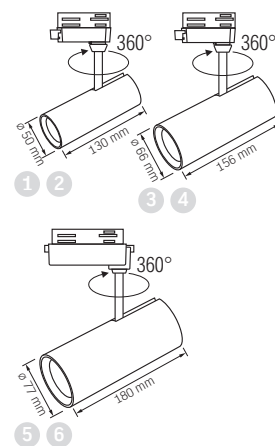

An ideal solution for accent lighting and an indispensable attribute of modern interiors and retail space. Track lights can favorably emphasize certain details of any composition. A feature of VIDEX track lights is their high color rendering index. The most clear display of the natural color of illuminated objects.

Idealne rozwiązanie do oświetlenia akcentującego i nieodzowny atrybut nowoczesnych wnętrz i powierzchni handlowych. Światła szynowe mogą korzystnie podkreślić pewne szczegóły dowolnej kompozycji. Cechą lamp szynowych VIDEX jest ich wysoki współczynnik oddawania barw. Najbardziej wyraźny obraz naturalnego koloru oświetlanych przedmiotów.



SPOT FIXTURE
track-mounted



1	VL-SPF05C-W	○	VIDEX-GU10-SKOT-WHITE	30 W	GU10	Aluminum	4820246482172
2	VL-SPF05C-B	●	VIDEX-GU10-SKOT-BLACK	30 W	GU10	Aluminum	4820246482141
3	VL-SPF06C-W	○	VIDEX-GU10-LONZO-WHITE	30 W	GU10	Aluminum	4820246482189
4	VL-SPF06C-B	●	VIDEX-GU10-LONZO-BLACK	30 W	GU10	Aluminum	4820246482097

The lamp is not included.
Nie ma źródła światła w zestawie.

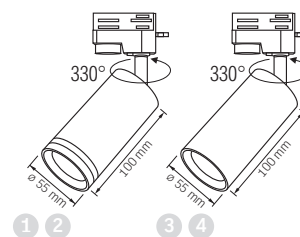



SPOT FIXTURE
track-mounted



The lamp is not included.
Nie ma źródła światła w zestawie.

VL-SPF17C-B ● 30 W GX53 Aluminum 4820246484695

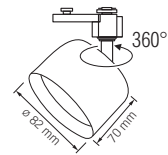

ACCESSORIES FOR MOUNTING TRACK SYSTEMS
AKCESORIA DO MONTAŻU SYSTEMÓW SZYNOWYCH



1m

Busbar for fixing and power supplying of the track lights.
Szyna do mocowania i zasilania lamp szynowych.
1000x34x20 mm



VLE-TRF001-W ○ 5904405541586
VLE-TRF001-B ● 5904405541593



2m

Busbar for fixing and power supplying of the track lights.
Szyna do mocowania i zasilania lamp szynowych.
2000x34x20 mm



VLE-TRF002-W ○ 5904405541609
VLE-TRF002-B ● 5904405541616



3m

Busbar for fixing and power supplying of the track lights.
Szyna do mocowania i zasilania lamp szynowych.
3000x34x20 mm



VLE-TRF003-W ○ 5904405541623
VLE-TRF003-B ● 5904405541630



Straight busbar connector.
Łącznik szynowy prosty.
78x44x22 mm



VLE-TRF-CTI-W ○ 5904405541647
VLE-TRF-CTI-B ● 5904405541654



Corner busbar connector.
Łącznik szynowy kątowy.
72x72x20 mm



VLE-TRF-CTL-W ○ 5904405541661
VLE-TRF-CTL-B ● 5904405541678



T-shaped busbar connector.
Łącznik szynowy w kształcie litery T.
95x65x16 mm



VLE-TRF-CTT-W ○ 5904405541685
VLE-TRF-CTT-B ● 5904405541692



Cross busbar connector.
Łącznik szynowy krzyżowy.
95x95x16 mm



VLE-TRF-CTX-W ○ 5904405541708
VLE-TRF-CTX-B ● 5904405541715



Suspended mounting kit for busbar trunking.
Podwieszany zestaw montażowy do szynoprzewodów.
L: 1000 mm



VLE-TRF-PD-W ○ 5904405541722
VLE-TRF-PD-B ● 5904405541739



Connector set 1-phase + end cap.
Zestaw złącz 1-fazowy + zaślepka.
109x19x35 mm



VLE-TRF-TM-W ○ 5904405541746
VLE-TRF-TM-B ● 5904405541753

VIDEX

LIGHT FIXTURES

A modern and comfortable alternative to traditional chandeliers and other lighting fixtures. The laconic design of the light fixtures fit perfectly into the interior of residential or office premises.

A large assortment allows to create a comfortable atmosphere in the room for relax or other activities, depending on the current needs of the consumer.

An impeccable combination of versatility and functionality.

Nowoczesna i wygodna alternatywa dla tradycyjnych żyrandoli i innych opraw oświetleniowych. Lakoniczny design opraw idealnie wpasowuje się we wnętrza lokali mieszkalnych lub biurowych.

Duży asortyment pozwala stworzyć w pomieszczeniu komfortową atmosferę do wypoczynku lub innych czynności, w zależności od aktualnych potrzeb konsumenta. Nienaganne połączenie wszechstronności i funkcjonalności.





CEILING LIGHT

1	VLE-CLR-244R	VIDEX-MILA-24W-NW	2500 lm	2160 lm	24 W	4000K	120°	F	5904405540565
2	VLE-CLR-484R	VIDEX-MILA-48W-NW	5160 lm	4320 lm	48 W	4000K	120°	F	5904405540572
3	VLE-CLR-244S	VIDEX-TOMA-24W-NW	2500 lm	2160 lm	24 W	4000K	120°	F	5904405540589
4	VLE-CLR-484S	VIDEX-TOMA-48W-NW	5160 lm	4320 lm	48 W	4000K	120°	F	5904405540596
5	VLE-CLR-484M	VIDEX-ZOYA-48W-NW	5160 lm	4320 lm	48 W	4000K	120°	F	5904405540602
6	VLE-CLS-484M	VIDEX-CLS-NATA-48W-NW	5160 lm	4320 lm	48 W	4000K	120°	F	5904405540619

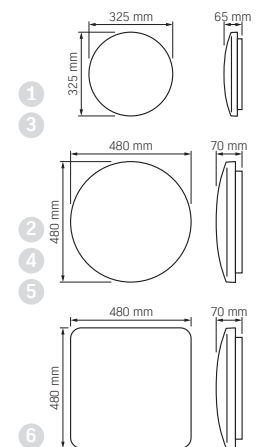

- AC 176-264V 50Hz
- Terminal Block
- Ra ≥ 80
- 30 000 h
- ON/OFF 20 000
- No Flicker
- IP44
- 20 ~ +40
- t°
- 3 YEARS Warranty



CEILING LIGHT

1	VLE-ERC-72W	VIDEX-LED-EDGE-RC-72W-WHITE	7500 lm	4700 lm	72 W	2700-6000K	120°	F	5904405542187
2	VLE-ERC-72B	VIDEX-LED-EDGE-RC-72W-BLACK	7500 lm	4700 lm	72 W	2700-6000K	120°	F	5904405542194
3	VLE-ESC-72W	VIDEX-LED-EDGE-SC-72W-WHITE	7500 lm	4700 lm	72 W	2700-6000K	120°	F	5904405542248
4	VLE-ESC-72B	VIDEX-LED-EDGE-SC-72W-BLACK	7500 lm	4700 lm	72 W	2700-6000K	120°	F	5904405542255

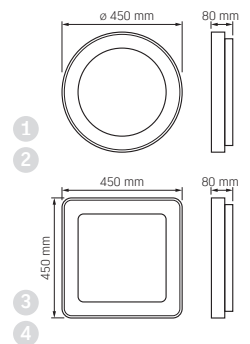

- AC 175-265V 50Hz
- Terminal Block
- Ra ≥ 80
- 35 000 h
- ON/OFF 20 000
- No Flicker
- IP20
- 20 ~ +40
- t°
- 3 YEARS Warranty

Functional interior lamps that can change the brightness, color temperature, have timers and a nice rear ceiling backlight. The lamp is controlled by the remote control or the wall switch.

Funkcjonalne lampy wewnętrzne, które mogą zmienić jasność, temperaturę kolorów, mają liczniki i ładne tylne podświetlenie sufitowe. Lampa jest kontrolowana przez pilot lub przełącznik ścienny.



CEILING LIGHT



1	VLE-ERC-72W	VIDEX-LED-EDGE-RC-RGB-72W-WHITE	7500 lm	4700 lm	72 W	2700-6000K	120°	F	5904405542224
2	VLE-ERC-72B	VIDEX-LED-EDGE-RC-RGB-72W-BLACK	7500 lm	4700 lm	72 W	2700-6000K	120°	F	5904405542231

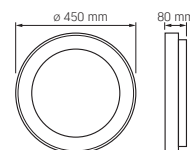

Functional lamps, which in addition to regulating brightness and color, have added many modes of color lighting, which will create a wonderful atmosphere in the interior.

Lampy funkcjonalne, które oprócz regulacji jasności i koloru dodały wiele sposobów oświetlenia kolorów, które stworzą wspaniałą atmosferę we wnętrzu.

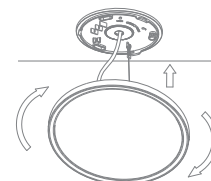

Removable base for convenient installation.
Wyjmowana baza dla wygodnej instalacji.

CEILING LIGHT
with rear backlight



1	VL-DL3R-184W	VIDEX-LED-CEILING-DL3R-18W-WHITE-4K	2000 lm	1800 lm	18 W	4000K ○	120°	F	4820246484350
2	VL-DL3R-184B	VIDEX-LED-CEILING-DL3R-18W-BLACK-4K	2000 lm	1800 lm	18 W	4000K ○	120°	F	4820246484343
3	VL-DL3S-244W	VIDEX-LED-CEILING-DL3S-24W-WHITE-4K	2900 lm	2400 lm	24 W	4000K ○	120°	E	4820246485234
4	VL-DL3S-244B	VIDEX-LED-CEILING-DL3S-24W-BLACK-4K	2900 lm	2400 lm	24 W	4000K ○	120°	E	4820246485227

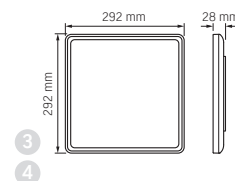
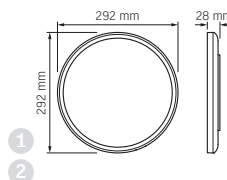



**LED EMERGENCY
CEILING LIGHT**
with motion sensor

VL-CLR-EM300-2	[lm] max. 3000 lm	[W] max. 30 W	[K] 2700K / 3000K / 4000K / 5000K / 6500K	[°] 120°	 Li-ion 3.7V 2200 mAh	[°] 120°	[M] 5 m	 4820246485456
----------------	----------------------	------------------	---	-------------	-----------------------------	-------------	------------	-------------------

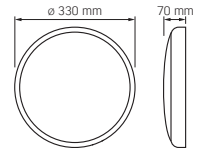

AC 175-265V 50Hz	Terminal Block	CRI Ra ≥ 80	25 000 h	ON/OFF 20 000	No Flicker	IP44		IK07	t^c -20 ~ +40	3 YEARS Warranty
---------------------	-------------------	-----------------------	----------	------------------	------------	-------------	--	-------------	-----------------------------------	--------------------------------

A unique luminaire with emergency backup lighting that works up to 6 hours without electricity. The product contains physical switches that allow you to change power, five different temperatures of light, adjust the motion sensor mode. The lamp is equipped with replaceable Li-ion batteries of the common type 18650, which can be replaced without much effort.

Wyjątkowa oprawa z awaryjnym oświetleniem zapasowym, która działa do 6 godzin bez prądu. Produkt zawiera fizyczne przełączniki umożliwiające zmianę mocy, pięć różnych temperatur świecenia, regulację trybu czujnika ruchu. Lampa wyposażona jest w wymienne akumulatory litowo-jonowe popularnego typu 18650, które można wymienić bez większego wysiłku.



Emergency backup light
300 lm, 6 h

Clear cover, dust-proof, insect-proof,
anti-electric shock

Linkable terminal block

Replaceable battery
18650 Li-ion 3.7 V 2200 mAh x2

Mode setting:
ON / DAY SENSOR / NIGHT SENSOR

Motion sensor delay
30 s. / 60 s. / 180 s.

Color switch:
2700K/3000K/4000K/5000K/6500K

Power switch:
15W / 25W / 30W



SPOT FIXTURE
surface-mounted



The lamp is not included.
Nie ma źródła światła w zestawie.

1	VL-SPF01-W ○	VIDEX-GU10-OTTO-WHITE	30 W	GU10	+	Aluminum	4820246482042
2	VL-SPF01-B ●	VIDEX-GU10-OTTO-BLACK	30 W	GU10	+	Aluminum	4820246482028

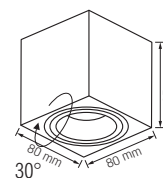

SPOT FIXTURE
surface-mounted



The lamp is not included.
Nie ma źródła światła w zestawie.

1	VL-SPF02A-WP ○	VIDEX-GU10-TALEN-WHITE	30 W	GU10	Aluminum	4820246482004
2	VL-SPF02A-BP ●	VIDEX-GU10-TALEN-BLACK	30 W	GU10	Aluminum	4820246482011
3	VL-SPF05A-W ○	VIDEX-GU10-CARMELO-WHITE	30 W	GU10	Aluminum	4820246482127
4	VL-SPF05A-B ●	VIDEX-GU10-CARMELO-BLACK	30 W	GU10	Aluminum	4820246482202
5	VL-SPF03A-SPW ○	VIDEX-GU10-TREVOR-WHITE	30 W	GU10	Aluminum	4820246482066
6	VL-SPF03A-SPB ●	VIDEX-GU10-TREVOR-BW	30 W	GU10	Aluminum	4820246482103

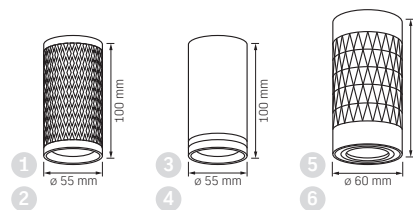

SPOT FIXTURE
surface-mounted



The lamp is not included.
Nie ma źródła światła w zestawie.

1	VL-SPF04A-WPW ○	VIDEX-GU10-STANLEY-WHITE	30 W	GU10	+	Aluminum	4820246482035
2	VL-SPF04A-BPB ●	VIDEX-GU10-STANLEY-BLACK	30 W	GU10	+	Aluminum	4820246481953
3	VL-SPF04A-WFW ○	VIDEX-GU10-PAUL-WHITE	30 W	GU10	+	Aluminum	4820246481977
4	VL-SPF04A-BFB ●	VIDEX-GU10-PAUL-BLACK	30 W	GU10	+	Aluminum	820246481960

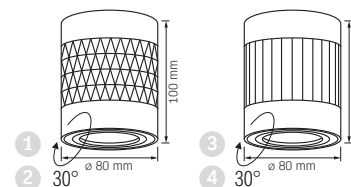



SPOT FIXTURE
surface-mounted, swivel



The lamp is not included.
Nie ma źródła światła w zestawie.

1	VL-SPF02B-WP ○	VIDEX-GU10-GRANT-WHITE	30 W	GU10	Aluminum	4820246481984
2	VL-SPF02B-BP ●	VIDEX-GU10-GRANT-BLACK	30 W	GU10	Aluminum	4820246481991
3	VL-SPF05B-W ○	VIDEX-GU10-MARTIN-WHITE	30 W	GU10	Aluminum	4820246482134
4	VL-SPF05B-B ●	VIDEX-GU10-MARTIN-BLACK	30 W	GU10	Aluminum	4820246482165

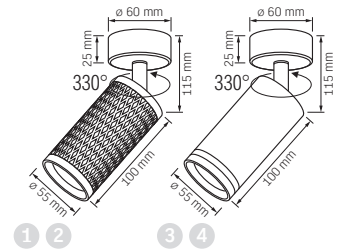

SPOT FIXTURE
surface-mounted, swivel



The lamp is not included.
Nie ma źródła światła w zestawie.

1	VL-SPF07-WB ○	VIDEX-2XGU10-ARIZA-WHITE	2x30W	GU10	Aluminum	4820246482059
2	VL-SPF07-B ●	VIDEX-2XGU10-ARIZA-BLACK	2x30W	GU10	Aluminum	4820246482196

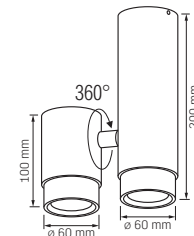

SPOT FIXTURE
wall-mounted, swivel



The lamp is not included.
Nie ma źródła światła w zestawie.

1	VL-SPF05E-W ○	VIDEX-GU10-KENT-WHITE	30 W	GU10	Aluminum	4820246482073
2	VL-SPF05E-B ●	VIDEX-GU10-KENT-BLACK	30 W	GU10	Aluminum	4820246483032

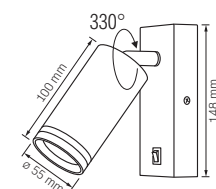



SPOT FIXTURE
surface-mounted



The lamp is not included.
Nie ma źródła światła w zestawie.

1	VL-SPF12A-W ○	30 W	GU10	+	Aluminum	4820246483018
2	VL-SPF12A-B ●	30 W	GU10	+	Aluminum	4820246482929
3	VL-SPF13A-W ○	30 W	GU10	+	Aluminum	4820246482905
4	VL-SPF13A-B ●	30 W	GU10	+	Aluminum	4820246483001

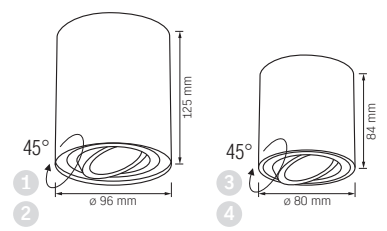

IP20
t^c
-25 ~ +50
2 YEARS
Warranty



SPOT FIXTURE
surface-mounted



The lamp is not included.
Nie ma źródła światła w zestawie.

1	VL-SPF14A-WB ○	30 W	GU10	Aluminum	4820246482998
2	VL-SPF14A-B ●	30 W	GU10	Aluminum	4820246482912

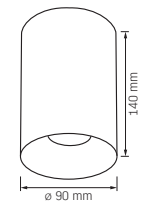

IP20
t^c
-25 ~ +50
2 YEARS
Warranty



SPOT FIXTURE
recessed-mounted



The lamp is not included.
Nie ma źródła światła w zestawie.

1	VL-SPF09R-W ○	30 W	GU10	Aluminum	4820246482967
2	VL-SPF09R-B ●	30 W	GU10	Aluminum	4820246482899
3	VL-SPF09S-W ○	30 W	GU10	Aluminum	4820246482974
4	VL-SPF09S-B ●	30 W	GU10	Aluminum	4820246482882

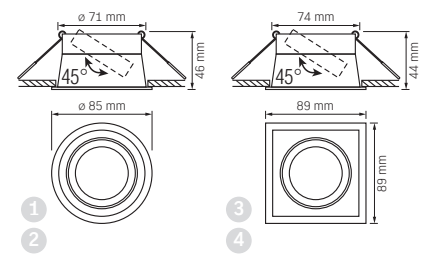

IP20
t^c
-25 ~ +50
2 YEARS
Warranty



SPOT FIXTURE
recessed-mounted



1	VL-SPF08R-W ○	30 W	GU10	+	Aluminum	4820246482950
2	VL-SPF08R-B ●	30 W	GU10	+	Aluminum	4820246482875
3	VL-SPF08S-W ○	30 W	GU10	+	Aluminum	4820246482868
4	VL-SPF08S-B ●	30 W	GU10	+	Aluminum	4820246482943

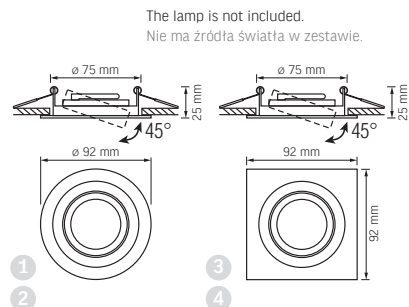

SPOT FIXTURE
recessed-mounted



1	VL-SPF10R-W ○	30 W	GU10	Aluminum	4820246482851
2	VL-SPF11R-W ○	30 W	GU10	Aluminum	4820246482936

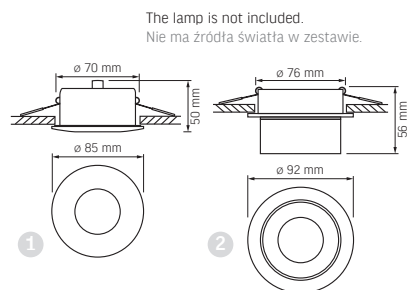

SPOT FIXTURE
pendant-mounted



1	VL-SPF05D-W ○	VIDEX-GU10-TATUM-WHITE	30 W	GU10	Aluminum	4820246482158
2	VL-SPF05D-B ●	VIDEX-GU10-TATUM-BLACK	30 W	GU10	Aluminum	4820246482080



The lamp is not included.
Nie ma źródła światła w zestawie.

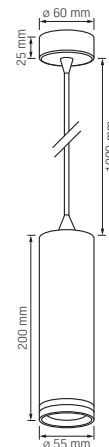



SPOT FIXTURE
surface-mounted



The lamp is not included.
Nie ma źródła światła w zestawie.

1	VL-SPF15A-W ○	30 W	GX53	Aluminum	4820246484664
2	VL-SPF15A-B ●	30 W	GX53	Aluminum	4820246484657
3	VL-SPF19A-W ○	30 W	GX53	Aluminum	4820246484725
4	VL-SPF19A-B ●	30 W	GX53	Aluminum	4820246485166

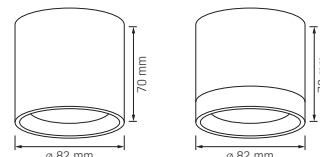

SPOT FIXTURE
surface-mounted



The lamp is not included.
Nie ma źródła światła w zestawie.

1	VL-SPF16A-W ○	30 W	GX53	Aluminum	4820246484688
2	VL-SPF16A-B ●	30 W	GX53	Aluminum	4820246484671

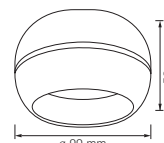

SPOT FIXTURE
surface-mounted, swivel



The lamp is not included.
Nie ma źródła światła w zestawie.

1	VL-SPF18B-W ○	30 W	GX53	Aluminum	4820246484718
2	VL-SPF18B-B ●	30 W	GX53	Aluminum	4820246484701

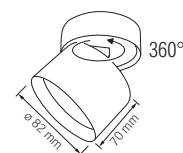



CEILING
SPOT FIXTURE
surface-mounted



1	VL-SPF20B-W ○	3x30W	GX53	Aluminum	4820246484749
2	VL-SPF20B-B ●	3x30W	GX53	Aluminum	4820246484732

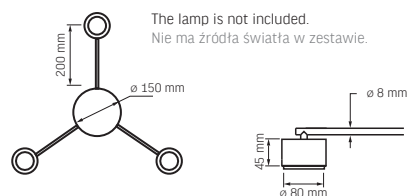

The lamp is not included.
Nie ma źródła światła w zestawie.



CEILING
SPOT FIXTURE
surface-mounted



1	VL-SPF21B-W ○	6x30W	GX53	Aluminum	4820246484763
2	VL-SPF21B-B ●	6x30W	GX53	Aluminum	4820246484756

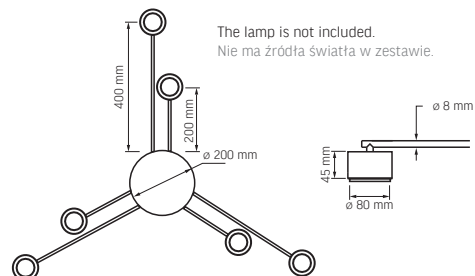

The lamp is not included.
Nie ma źródła światła w zestawie.



CEILING
SPOT FIXTURE
surface-mounted



1	VL-SPF22B-W ○	8x30W	GX53	Aluminum	4820246484787
2	VL-SPF22B-B ●	8x30W	GX53	Aluminum	4820246484770

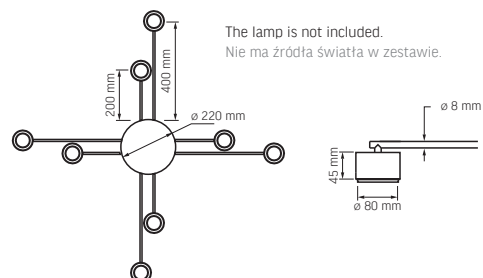

The lamp is not included.
Nie ma źródła światła w zestawie.



FRAME PANEL

VLE-PA404W	VIDEX-FRAME-PANEL-LED-40W-PA404W-NW	4500 lm	4000 lm	40 W	4000K	120°	E	5904405541029
------------	-------------------------------------	---------	---------	------	-------	------	---	---------------

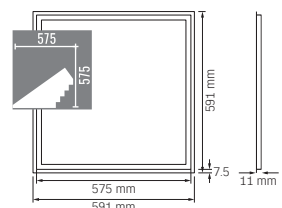

LED frame panels can act not only as a practical light source, but also as a decorative design element. They can also be suspended (see mounting accessories).

Panele LED typu ramowego mogą pełnić rolę nie tylko praktycznego źródła światła, ale także dekoracyjnego elementu wystroju. Można je również podwiesić (patrz akcesoria montażowe).

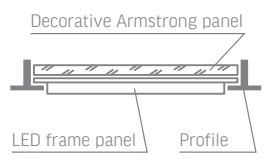

FRAME PANEL
disassemblable

VLE-PAU405W	VIDEX-FRAME-PANEL-LED-40W-PAU405W-NW5	5100 lm	5000 lm	40 W	5000K	120°	D	5904405542385
-------------	---------------------------------------	---------	---------	------	-------	------	---	---------------

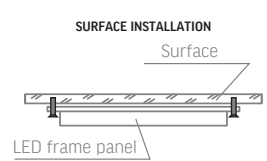
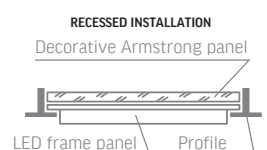
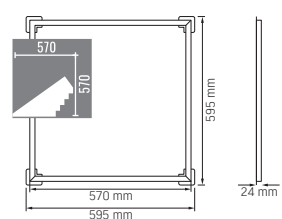

The disassemblable design of the frame panel for more convenient transportation.
Demontażowa struktura panelu ramy dla wygodniejszego transportu.





SLIM PANEL



1	VLE-P404W	VIDEX-PANEL-LED-40W-P404W-NW	5200 lm	4000 lm	40 W	4000K	○	120°	D	5904405540626
1	VLE-P406W	VIDEX-PANEL-LED-40W-P406W-CW	5200 lm	4000 lm	40 W	6000K	●	120°	D	5904405540633
2	VLE-P62-404W	VIDEX-PANEL-LED-40W-P62-404W-NW	5200 lm	4000 lm	40 W	4000K	○	120°	D	5904405540640
2	VLE-P62-406W	VIDEX-PANEL-LED-40W-P62-406W-CW	5200 lm	4000 lm	40 W	6000K	●	120°	D	5904405540657



LED panels are the optimal way for large offices, retail and other premises. Easy placed in suspended ceilings, they illuminate large areas evenly.

Panele LED to optymalny sposób na oświetlenie dużych biur, lokali handlowych lub usługowych oraz innych pomieszczeń. Łatwe do zamontowania w sufitach podwieszanych, co pozwoli równomiernie oświetlić duże obszary.

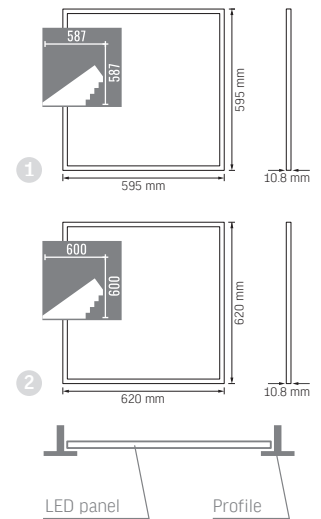

BACKLIT PANEL

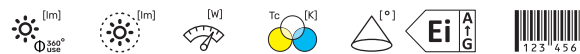

	VLE-PB404W	VIDEX-PANEL-LED-40W-PB404W-NW	5100 lm	4400 lm	40 W	4000K	○	160°	D	5904405542408
--	------------	-------------------------------	---------	---------	------	-------	---	------	---	---------------



With the new structure of the LEDs placement, the panels have a even light distribution and a light diffuser that is largely protected from the yellowing factor.

Dzięki nowej strukturze rozmieszczenia diod LED panele charakteryzują się równomiernym rozsyłem światła, a dyfuzor światła jest w dużym stopniu chroniony przed czynnikiem żółknięcia.

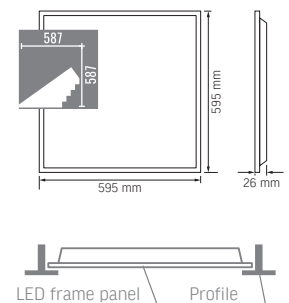

MOUNTING ACCESSORIES FOR LED PANELS

LED panels can be placed on almost any surface with help of various range of additional mounting aids. The big choice of the type of installation allows LED panels to become an aesthetically perfect and functionally justified element of any interior.

AKCESORIA MONTAŻOWE DO PANELI LED

Dzięki szerokiej gamie akcesoriów montażowych panele LED można umieszczać na praktycznie każdej powierzchni, zarówno pionowej, jak i poziomej. Brak ograniczeń w doborze sposobu montażu sprawia, że panele LED stają się estetycznie doskonałym i funkcjonalnie uzasadnionym elementem każdego wnętrza.

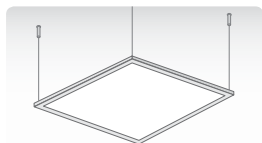

VL-PFT

VIDEX-LED-PANEL-SUSPENSION-SET

L=600 mm

LED panel suspended mounting kit.
Zestaw do montażu podwieszanego panelu LED na linkach.

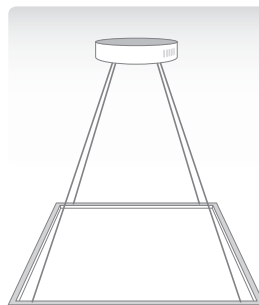
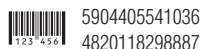

VL-PFTC

VIDEX-LED-PANEL-CANOPY-SUSPENSION-SET

L=600 mm

Suspended mounting kit with canopy.
Zwieszany zestaw montażowy z rozetą.

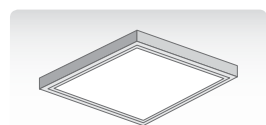
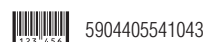

VL-PFS ○ WHITE

VIDEX-LED-PANEL-SURFACE-MOUNTED-FRAME-6060

600x600x50 mm

LED panel mounting box for surface installation.

Ramka do montażu natynkowego paneli LED.

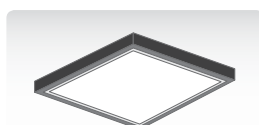
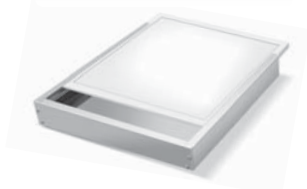
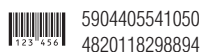

VL-PFS-B ● BLACK

VIDEX-LED-PANEL-SURFACE-MOUNTED-FRAME-6060

600x600x50 mm

LED panel mounting box for surface installation.

Ramka do montażu natynkowego paneli LED.

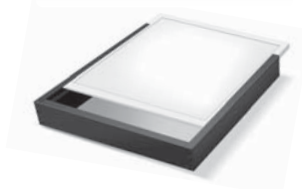
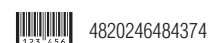



DOWNLIGHT
recessed-mounted



		[lm]	[lm]	PON [W]	Tc [K]	[°]				
1	VLE-DLBR-044	VIDEX-DOWNLIGHT-LED-DLBR-044-4W-NW	380 lm	240 lm	4 W	4000K	○	120°	F	5904405540855
2	VLE-DLBR-064	VIDEX-DOWNLIGHT-LED-DLBR-064-6W-NW	620 lm	420 lm	6 W	4000K	○	120°	F	5904405540862
3	VLE-DLBR-124	VIDEX-DOWNLIGHT-LED-DLBR-124-12W-NW	1350 lm	900 lm	12 W	4000K	○	120°	E	5904405540879
4	VLE-DLBR-184	VIDEX-DOWNLIGHT-LED-DLBR-184-18W-NW	2100 lm	1450 lm	18 W	4000K	○	120°	E	5904405540886
5	VLE-DLBS-064	VIDEX-DOWNLIGHT-LED-DLBS-064-6W-NW	620 lm	450 lm	6 W	4000K	○	120°	F	5904405540893
6	VLE-DLBS-124	VIDEX-DOWNLIGHT-LED-DLBS-124-12W-NW	1400 lm	950 lm	12 W	4000K	○	120°	E	5904405540909
7	VLE-DLBS-184	VIDEX-DOWNLIGHT-LED-DLBS-184-18W-NW	2200 lm	1500 lm	18 W	4000K	○	120°	E	5904405540916



Low profile downlights are easy to install. The housing is made from a fire-proof and anti-yellowing polymer.

Niski profilu jest łatwy w instalacji. Obudowa jest wykonana z ognioodpornego i przeciwdziałającego polimeru.

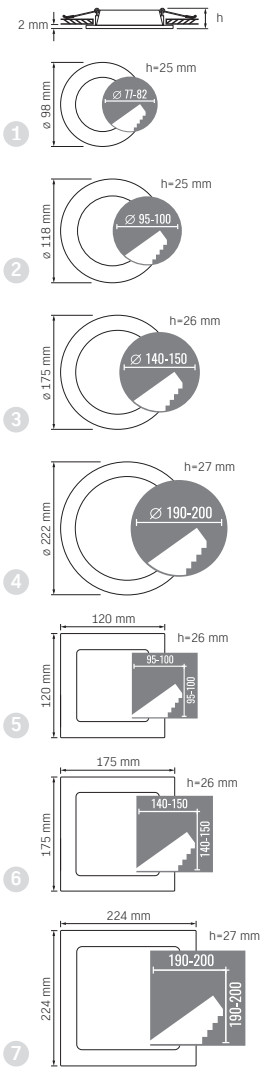



Adjustable fixing mechanism provides maximum convenience by installing the fixture. A terminal block is included.

Regulowany mechanizm mocowania zapewnia maksymalną wygodę podczas montażu oprawy. W zestawie listwa zaciskowa.

FRAMELESS DOWNLIGHT recessed-mounted

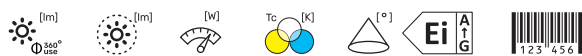

		(lm)	(lm)	[W]	T _c [K]	[°]				
1	VLE-DLFR-094	VIDEX-DOWNLIGHT-LED-DLFR-9W-NW	950 lm	760 lm	9 W	4000K	○	120°	F	5904405540787
2	VLE-DLFR-154	VIDEX-DOWNLIGHT-LED-DLFR-15W-NW	1950 lm	1500 lm	15 W	4000K	○	120°	E	5904405540794
3	VLE-DLFR-244	VIDEX-DOWNLIGHT-LED-DLFR-24W-NW	2950 lm	2360 lm	24 W	4000K	○	120°	E	5904405540800
4	VLE-DLFS-094	VIDEX-DOWNLIGHT-LED-DLFS-9W-NW	1000 lm	810 lm	9 W	4000K	○	120°	F	5904405540817
5	VLE-DLFS-154	VIDEX-DOWNLIGHT-LED-DLFS-15W-NW	2100 lm	1650 lm	15 W	4000K	○	120°	E	5904405540824
6	VLE-DLFS-244	VIDEX-DOWNLIGHT-LED-DLFS-24W-NW	3200 lm	2550 lm	24 W	4000K	○	120°	E	5904405540831

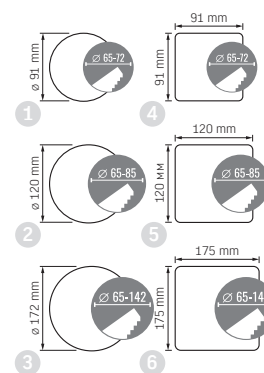

FRAMES FOR SURFACE INSTALLATION RAMY DO INSTALACJI POWIERZCHNI



VL-DLFR-09SF

∅ 96 x 34 mm

Compatible with / Kompatybilny z VL-DLFR-094

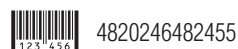

4820246482455

VL-DLFR-15SF

∅ 126 x 32 mm

Compatible with / Kompatybilny z VIDEX VL-DLFR-094

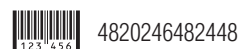

4820246482448

VL-DLFR-24SF

∅ 179 x 32 mm

Compatible with / Kompatybilny z VIDEX VL-DLFR-244

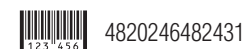

4820246482431



VL-DLFS-09SF

97 x 97 x 34 mm

Compatible with / Kompatybilny z VIDEX VL-DLFS-094

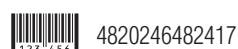

4820246482417

VL-DLFS-15SF

128 x 128 x 32 mm

Compatible with / Kompatybilny z VIDEX VL-DLFS-154

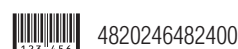

4820246482400

VL-DLFS-24SF

179 x 179 x 32 mm

Compatible with / Kompatybilny z VIDEX VL-DLFS-244



4820246482424



These downlight fixtures have thin frames, what make them conspicuous from other analogues.

Te oprawy LED downlight mają cienkie ramki, co wyróżnia je spośród innych analogów.

DOWNLIGHT
surface-mounted



1	VLE-DLRS-124 ○ VIDEX-DOWNLIGHT-LED-DLRS-12W-NW	1250 lm	900 lm	12 W	4000K ○	170°	E	5904405540725
2	VLE-DLRS-184 ○ VIDEX-DOWNLIGHT-LED-DLRS-18W-NW	1850 lm	1400 lm	18 W	4000K ○	170°	E	5904405540732
3	VLE-DLRS-184B ● VIDEX-DOWNLIGHT-LED-DLRS-BLACK-18W-NW	1850 lm	1400 lm	18 W	4000K ○	170°	E	5904405542521
4	VLE-DLRS-244 ○ VIDEX-DOWNLIGHT-LED-DLRS-24W-NW	2500 lm	2000 lm	24 W	4000K ○	170°	E	5904405540749
5	VLE-DLRS-244B ● VIDEX-DOWNLIGHT-LED-DLRS-BLACK-24W-NW	2500 lm	2000 lm	24 W	4000K ○	170°	E	5904405542538
6	VLE-DLSS-124 ○ VIDEX-DOWNLIGHT-LED-DLSS-12W-NW	1250 lm	820 lm	12 W	4000K ○	170°	E	5904405540756
7	VLE-DLSS-184 ○ VIDEX-DOWNLIGHT-LED-DLSS-18W-NW	1850 lm	1400 lm	18 W	4000K ○	170°	E	5904405540763
8	LE-DLSS-184B ● VIDEX-DOWNLIGHT-LED-DLSS-BLACK-18W-NW	1850 lm	1400 lm	18 W	4000K ○	170°	E	5904405542507
9	VLE-DLSS-244 ○ VIDEX-DOWNLIGHT-LED-DLSS-24W-NW	2500 lm	1830 lm	24 W	4000K ○	170°	E	5904405540770
10	VLE-DLSS-244B ● VIDEX-DOWNLIGHT-LED-DLSS-BLACK-24W-NW	2500 lm	1830 lm	24 W	4000K ○	170°	E	5904405542514

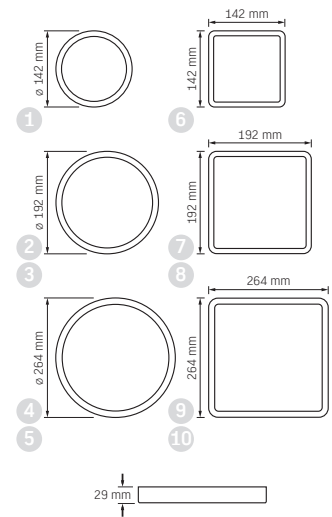

VIDEX

OUTDOOR LUMINAIRES

Widely used for the lighting of home areas and playgrounds. Modern outdoor lamps, in addition to the function of general lighting, should also have a beautiful appearance, complementing the facade or interior where they are installed.

Szeroko stosowany do oświetlenia obszarów domowych i placów zabaw. Nowoczesne lampy zewnętrzne, oprócz funkcji oświetlenia ogólnego, powinny także charakteryzować się pięknym wyglądem, stanowiącym uzupełnienie elewacji lub wnętrza, w którym są zamontowane.



OVERHEAD LUMINAIRES

With the high grade of dust and moisture protection up to IP65, bulkhead luminaires are good choice for installation in outdoor residential areas and passages. The absence of the flickering effect makes it possible to install the lights in rooms with a high level of moisture.

Manufacturing our luminaires, we use high-quality polymers with the addition of anti-yellowing substances that preserve the original color of the housing for a long time.

Main advantages: Unique design, durable body, ease of installation.

Application area: Outdoor walls, passages, corridors and bathrooms.



OPRAWY POWIERZCHNIOWE

Dzięki wysokiemu stopniowi ochrony przed kurzem i wilgocią do IP65, oprawy grodziowe są dobrym wyborem do montażu w zewnętrznych obszarach mieszkalnych i przejściach. Brak efektu migotania umożliwia montaż opraw w pomieszczeniach o dużej wilgotności.

Do produkcji naszych opraw stosujemy wysokiej jakości polimery z dodatkiem substancji zapobiegających żółknięciu, które na długo zachowują oryginalny kolor oprawy.

Główne zalety: Unikalny wygląd, trwały korpus, łatwość instalacji.

Obszar zastosowań: Ściany, fragmenty, korytarze i łazienki.

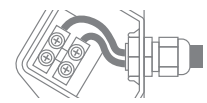

Built-in terminal block for convenient and reliable connection.

Wbudowana listwa zaciskowa zapewniająca wygodne i niezawodne połączenie.

BULKHEAD LIGHT

		(lm)	(lm)	(W)	(K)	(°)			
1	VLE-BH12R-185	VIDEX-BULKHEAD-LED-INGA-18W-NW	1900 lm	1440 lm	18 W	5000K ○	120°	F	5904405540961
2	VLE-BH120-155	VIDEX-BULKHEAD-LED-DANA-15W-NW	1600 lm	1200 lm	15 W	5000K ○	120°	F	5904405540954

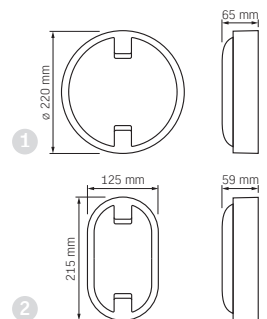

The housing and diffuser of the luminaire are made of thick UV-resistant plastic to prevent yellowing.

Korpus i klosz oprawy wykonane są z grubego tworzywa odpornego na promieniowanie UV, zapobiegającego żółknięciu.

A special cover hides the fixing points and gives the luminaire a decorative look.

Specjalna osłona ukrywa punkty mocowania i nadaje oprawie dekoracyjny wygląd.





Built-in terminal block for convenient and reliable connection.

Wbudowana listwa zaciskowa zapewniająca wygodne i niezawodne połączenie.

BULKHEAD LIGHT

1	VLE-BHFR-155	VIDEX-BULKHEAD-LED-LENA-15W-NW	1600 lm	1125 lm	15 W	5000K	120°	F	5904405540923
2	VLE-BHFR-155B	VIDEX-BULKHEAD-LED-LENA-BLACK-15W-NW	1600 lm	1125 lm	15 W	5000K	120°	F	5904405542569
3	VLE-BHFR-245	VIDEX-BULKHEAD-LED-LENA-24W-NW	2600 lm	1920 lm	24 W	5000K	120°	F	5904405542309
4	VLE-BHFS-155	VIDEX-BULKHEAD-LED-VIKA-15W-NW	1600 lm	1125 lm	15 W	5000K	120°	F	5904405540930
5	VLE-BHFS-155B	VIDEX-BULKHEAD-LED-VIKA-BLACK-15W-NW	1600 lm	1125 lm	15 W	5000K	120°	F	5904405542576
6	VLE-BHFS-245	VIDEX-BULKHEAD-LED-VIKA-24W-NW	2600 lm	1920 lm	24 W	5000K	120°	F	5904405542316
7	VLE-BHFO-115	VIDEX-BULKHEAD-LED-GALA-11W-NW	1200 lm	825 lm	11 W	5000K	120°	F	5904405540947

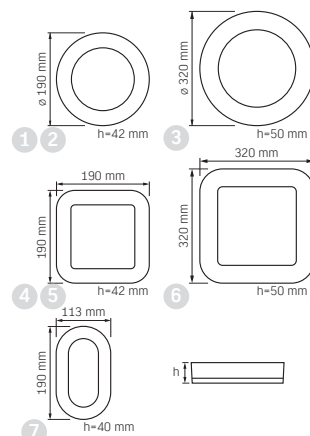

BULKHEAD LIGHT with motion detector

VLE-BHR-115W-SP	VIDEX-BULKHEAD-LED-PIR-KIRA-11W-NW	1200 lm	880 lm	11 W	5000K	120°	F	5904405540978
-----------------	------------------------------------	---------	--------	------	-------	------	---	---------------

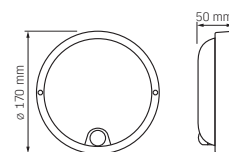

PASSIVE INFRARED MOTION SENSOR



**LED SOLAR
WALL LIGHT**
with motion detector



VL-BHSO-001-S 500 lm 5000K ○ 120° LiFePO₄ 6.4 Wh 3.2 V 2000 mAh 1.5 W 5.5 V 4820246485470



Replaceable battery
Wymienny akumulator

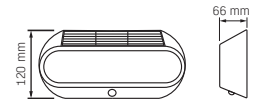

PASSIVE INFRARED MOTION SENSOR

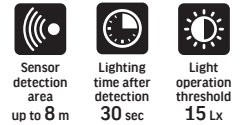

**LED SOLAR
WALL LIGHT**
with motion detector



VL-BHSO-002-S 500 lm 5000K ○ 120° LiFePO₄ 6.4 Wh 3.2 V 2000 mAh 1.5 W 5.5 V 4820246485487



Replaceable battery
Wymienny akumulator

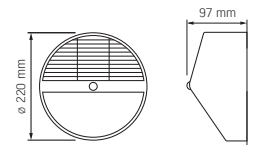

PASSIVE INFRARED MOTION SENSOR

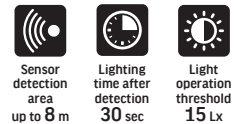

**LED SOLAR
WALL LIGHT**
with motion detector



VL-BHSO-003-S 500 lm 5000K ○ 120° LiFePO₄ 6.4 Wh 3.2 V 2000 mAh 1.5 W 5.5 V 4820246485494



Replaceable battery
Wymienny akumulator

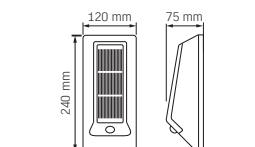

PASSIVE INFRARED MOTION SENSOR

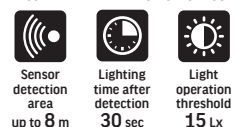

INDUSTRIAL LINEAR LUMINAIRES

Linear luminaires are one of the most suitable form factors for commercial premises. They are great for row lighting, such as in a supermarket or warehouse, and some of them can be connected to a main line, requiring only one connection point. For underground parking lots or basements, linear lamps with high moisture protection and a strong housing are ideal.





PRZEMYSŁOWE OPRAWY LINIOWE

Oprawy liniowe to jedne z najodpowiedniejszych rozwiązań dla obiektów komercyjnych. Świetnie nadają się do oświetlenia szeregowego, np. w supermarkecie czy magazynie, a niektóre z nich można podłączyć do linii głównej, wymagając tylko jednego punktu podłączenia.







Do parkingów podziemnych lub piwnic idealnie nadają się lampy liniowe o wysokiej ochronie przed wilgocią i mocnej obudowie.

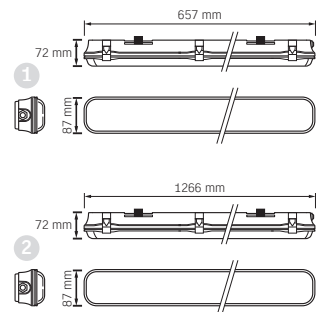

WATERPROOF T8 LAMP FIXTURE

				
1 VL-BNW-T8062G	Lamp type: T8 60cm	G13	max: 2 x 10W	4820246484824
2 VL-BNW-T8122G	Lamp type: T8 120cm	G13	max: 2 x 20W	4820246484831



 **IP65**   **IK08**  **-20 ~ +40**   **5 YEARS Warranty**

AC 220-240V 50Hz

The luminaire has a high level of moisture and impact resistance. The body and diffuser are made of high-quality polycarbonate. An ideal choice for public areas. A reflector is installed inside the lamp for efficient light output. The design of the product provides for quick replacement of the light source.

Oprawa charakteryzuje się wysokim stopniem odporności na wilgoć i uderzenia. Korpus i dyfuzor wykonane są z wysokiej jakości poliwęglanu. Idealny wybór do przestrzeni publicznych. Wewnątrz lampy zamontowany jest odbłyśnik zapewniający efektywny strumień świetlny. Konstrukcja produktu umożliwia szybką wymianę źródła światła.

Stainless steel clips.
Klipsy ze stali nierdzewnej.



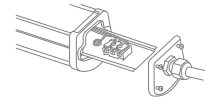

Built-in terminal block for convenient and reliable connection.

Wbudowana listwa zaciskowa zapewniająca wygodne i niezawodne połączenie.

WATERPROOF BATTEN LIGHT



1	VLE-BNW-24064	VIDEX-HERMES-60CM-24W-IP65-NW	2933 lm	2640 lm	24 W	4000K ○	120°	E	5904405541418
2	VLE-BNW-48124	VIDEX-HERMES-120CM-48W-IP65-NW	6000 lm	5280 lm	48 W	4000K ○	120°	E	5904405541425



The luminaire is completely protected from dust and moisture getting inside. The high quality plastic unibody has excellent mechanical resistance. The light source inside the luminaire can be easily replaced.

Oprawa jest całkowicie zabezpieczona przed przedostawaniem się kurzu i wilgoci do środka. Jednocześnie obudowa wykonana z wysokiej jakości tworzywa sztucznego charakteryzuje się doskonałą odpornością mechaniczną. Źródło światła wewnątrz oprawy można łatwo wymienić.

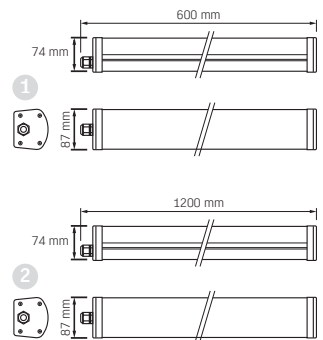

BATTEN LIGHT

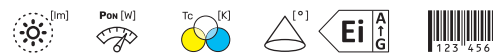

1	VLE-BN-36065B		4000 lm	36 W	5000K ○	120°	E	4820246484572
2	VLE-BN-72125B		8000 lm	72 W	5000K ○	120°	E	4820246484589



High power linear light. Strong aluminum body, the light diffuser made of polycarbonate, high energy efficiency and modern appearance.

Lampa liniowa o dużej mocy. Mocna aluminiowa obudowa, dyfuzor światła wykonany z poliwęglanu, wysoka energooszczędność i nowoczesny wygląd.

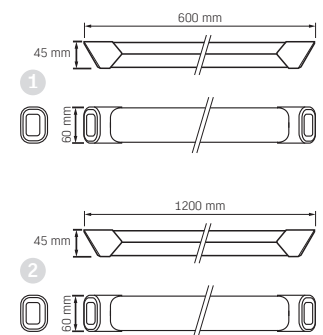



BATTEN LIGHT

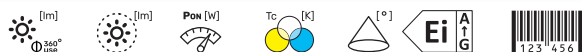

1	VLE-BN-27064	VIDEX-BATTEN-LED-27W-NW	3550 lm	2700 lm	27 W	4000K	○	120°	E	5904405541005
2	VLE-BN-50124	VIDEX-BATTEN-LED-50W-NW	6250 lm	5000 lm	50 W	4000K	○	120°	E	5904405541012



The aluminum body of higher thickness more effectively performs the function of heat dissipation, which further reduces the temperature load on the LEDs and slows down their technical degradation.

Aluminiowy korpus o większej grubości skuteczniej spełnia funkcję odprowadzania ciepła, co dodatkowo zmniejsza obciążenie temperaturowe diod LED i spowalnia ich degradację techniczną.

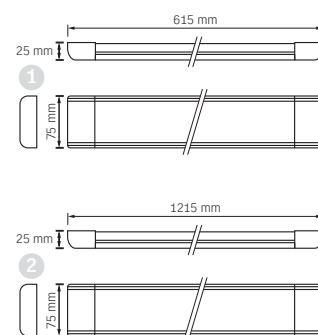

BATTEN LIGHT

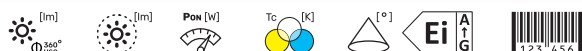

1	VLE-BN-18064	VIDEX-BATTEN-LED-18W-NW	2250 lm	1800 lm	18 W	4000K	○	120°	E	5904405540985
2	VLE-BN-36124	VIDEX-BATTEN-LED-36W-NW	4500 lm	3600 lm	36 W	4000K	○	120°	E	5904405540992







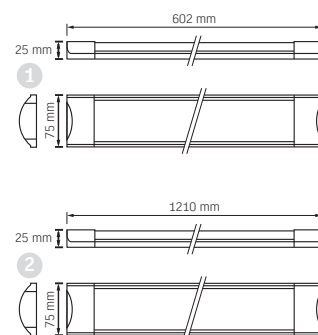

The cone-shaped placement of LEDs inside the housing helps to more evenly distribute the light throughout the room. The solid aluminum housing extends the life of the LEDs.

Stożkowe rozmieszczenie diod LED wewnątrz obudowy pozwala na bardziej równomierne rozprzowanie światła w pomieszczeniu. Solidna aluminiowa obudowa wydłuża żywotność diod LED.





LINKABLE BATTEN LIGHT

	 [lm]	 [lm]	 [W]	 [K]	 [°]		
1 VL-BNL02-24065B	2600 lm	2400 lm	24 W	5000K	90°		4820246485531
2 VL-BNL02-50125B	5300 lm	5000 lm	50 W	5000K	90°		4820246485548

 AC 170-265V 50Hz
 
 Ra ≥ 80
  50 000 h
  20 000
  No Flicker
  IP20
 
 t° -20 ~ +40
  5 YEARS Warranty

The modern aluminum housing, serial connection design, anti-glare light diffuser and long service life make this commercial line light probably the best choice for supermarket or office lighting.

Nowoczesna aluminiowa obudowa, konstrukcja połączenia szeregowego, antyodblaskowy dyfuzor światła i długa żywotność sprawiają, że ta lampa do linii komercyjnych jest prawdopodobnie najlepszym wyborem do oświetlenia supermarketów lub biur.

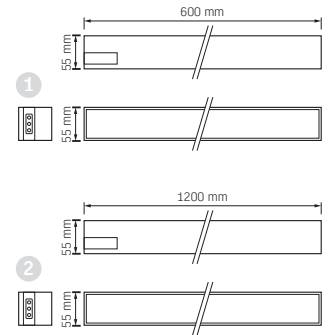

Through wiring for direct connection of a group of luminaires with a total power of up to 1000 watts.

Okablowanie przelotowe do bezpośredniego podłączenia grupy opraw o łącznej mocy do 1000 watów.

The floating connector for connection the lamps to each other at different angles.

Złącze pływające umożliwiające łączenie lamp ze sobą pod różnymi kątami.



ACCESSORIES / AKCESORIA



VL-BNL02-F05B

∅ 60 x 15 mm L:1500 mm

Suspendant installation kit
Zestaw do montażu wiszącego

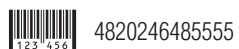

4820246485555



VL-BNL02-F01B

L: 30 cm 220 V

Power plug
Wtyczka zasilająca



4820246485562



VIDEX

Architek

OUTDOOR DESIGN LIGHTING SYSTEMS

A wide range of architectural LED fixtures makes it easy to make the choice depending on its task. They complement organically the landscape, create a comfortable atmosphere. Thanks to architectural lighting, they favorably emphasize the aesthetic features of structures and focus on details.

Szeroka gama architektonicznych opraw LED ułatwia dokonanie wyboru w zależności od zadania. Organicznie dopełniają krajobraz, tworzą komfortową atmosferę. Dzięki oświetleniu architektonicznemu korzystnie podkreślają się walory estetyczne konstrukcji i skupiają się na detalu.

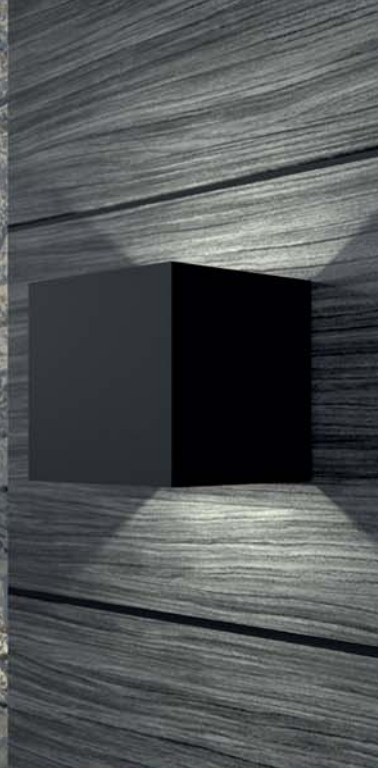

ARCHITECTURAL LED FIXTURES OF THE ARCHITEK SERIES

Designed for lighting of the facades of private houses, offices, terraces, fences or interiors. They emphasize the texture of surfaces and create a noble atmosphere of comfort. The minimalistic and modern design allows the fixtures to be used in almost any architectural lighting project.

OPRAWY ARCHITEKTONICZNE LED Z SERII ARCHITEK

Przeznaczone do oświetlenia elewacji domów prywatnych, biur, tarasów, ogrodzeń czy wnętrz. Podkreślają fakturę powierzchni i tworzą szlachetną atmosferę komfortu. Minimalistyczny i nowoczesny design pozwala na zastosowanie opraw w niemal każdym projekcie oświetlenia architektonicznego.

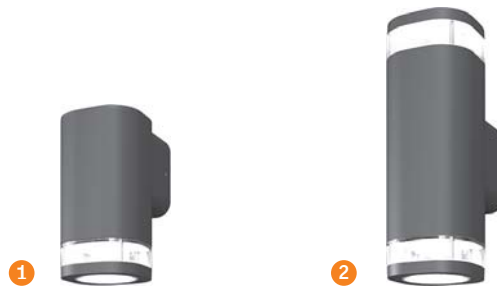

FACADE FIXTURE architectural

1	VL-AR071G	VIDEX-GU10-BRUNO-GRAY	50W	GU10	↓ down	Aluminum	4820246480864
2	VL-AR072G	VIDEX-2XGU10-BRUNO-GRAY	2x50W	GU10	↕ up and down	Aluminum	4820246480901



The lamp is not included.
Nie ma źródła światła w zestawie.

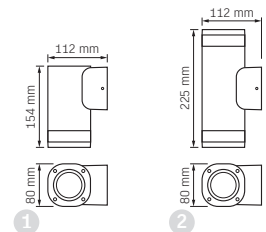

FACADE FIXTURE architectural

VL-AR082G	VIDEX-2XE27-PORTER-GRAY	2x50W	E27	↕ up and down	Aluminum	4820246482363
-----------	-------------------------	-------	-----	---------------	----------	---------------



The lamp is not included.
Nie ma źródła światła w zestawie.

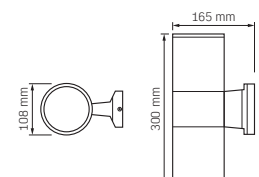



FACADE LIGHT
architectural



1	VL-AR04-062W	○	VIDEX-6W-ERIC-WHITE	480 lm	6 W	2700K	0-120°	↕ up and down	Aluminum	F	4820246480888
2	VL-AR04-062B	●	VIDEX-6W-ERIC-BLACK	480 lm	6 W	2700K	0-120°	↕ up and down	Aluminum	F	4820246480871

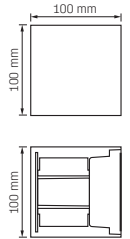

LED fixture with decorative curtains allows to adjust the lighting and additionally limit the scattering of the beam angle in undesirable directions to prevent unnecessary glare.

Oprawa wyposażona jest w ozdobne kurtyny, które pozwalają na regulację oświetlenia oraz dodatkowo ograniczają rozproszenie kąta padania światła w niepożądane kierunki zapobiegając niepotrzebnemu oświepleniu.

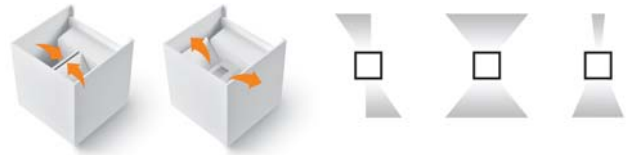

FACADE LIGHT
architectural



1	VL-AR06-062W	○	VIDEX-6W-EVAN-WHITE	660 lm	6 W	2700K	180°	↕ up and down	Aluminum	E	4820246480925
2	VL-AR06-062B	●	VIDEX-6W-EVAN-BLACK	660 lm	6 W	2700K	180°	↕ up and down	Aluminum	E	4820246480918

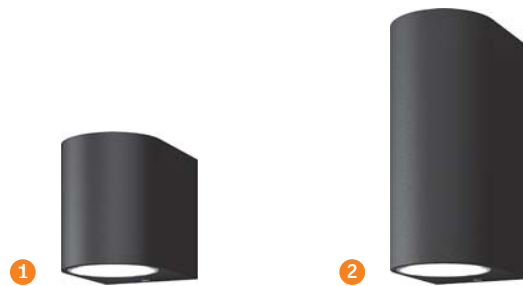
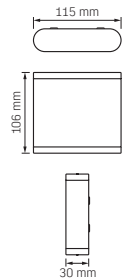

FACADE LIGHT
architectural



1	VL-AR031-032B		VIDEX-3W-PELLE-BLACK	180 lm	3 W	2700K	120°	⌵ down	Aluminum	F	4820246480857
2	VL-AR032-062B		VIDEX-6W-PELLE-BLACK	360 lm	6 W	2700K	120°	↕ up and down	Aluminum	F	4820246480895

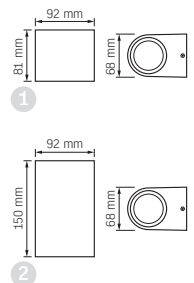

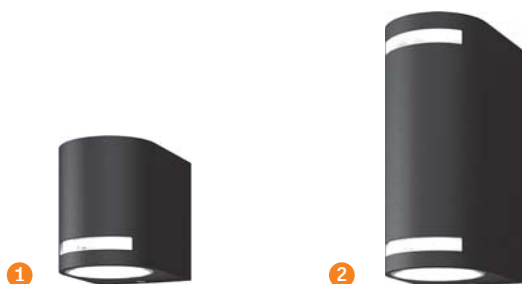

FACADE FIXTURE
architectural

1	VL-AR021B	VIDEX-GU10-JUSTIN-BLACK	50W	GU10	▼ down	Aluminum	4820246480833
2	VL-AR022B	VIDEX-2XGU10-JUSTIN-BLACK	2x50W	GU10	↕ up and down	Aluminum	4820246480840

IP44
2 YEARS Warranty

The lamp is not included.
Nie ma źródła światła w zestawie.

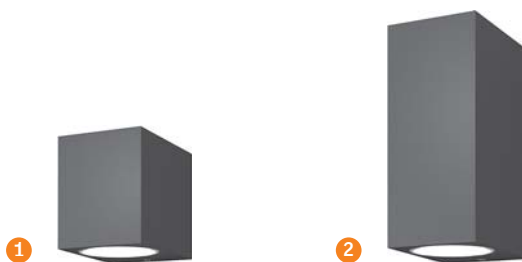
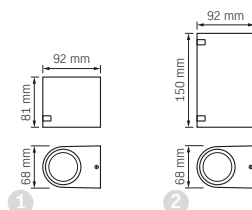

FACADE FIXTURE
architectural

1	VL-AR011G	VIDEX-GU10-ARON-GRAY	50W	GU10	▼ down	Aluminum	4820246480819
2	VL-AR012G	VIDEX-2XGU10-ARON-GRAY	2x50W	GU10	↕ up and down	Aluminum	4820246480826

IP44
2 YEARS Warranty

The lamp is not included.
Nie ma źródła światła w zestawie.

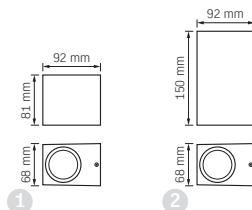

GARDEN LIGHT
architectural

1	VL-AR05-03062S	VIDEX-3W-LUKA-SILVER	270 lm	3 W	2700K	360°	↔ horizontally	Aluminum	F	4820246481083
2	VL-AR05-03082S	VIDEX-3W-LUKAS-SILVER	270 lm	3 W	2700K	360°	↔ horizontally	Aluminum	F	4820246480802

IP44
2 YEARS Warranty

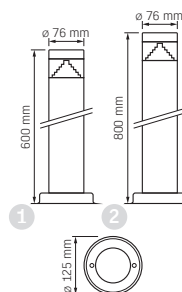

VIDEX

FLOOD & STREET LIGHTS

A group of outdoor lighting, which includes a wide range of lighting equipment of various forms, the general and main feature of which is protection against dust, moisture and mechanical influences.

We offer a variety of versatile solutions that are suitable for both the commercial and consumer sectors of the market.

Grupa oświetlenia zewnętrznego obejmująca szeroką gamę sprzętu oświetleniowego o różnej formie, którego ogólną i główną cechą jest ochrona przed kurzem, wilgocią i wpływami mechanicznymi.

Oferujemy różnorodne wszechstronne rozwiązania, które są odpowiednie zarówno dla sektora komercyjnego, jak i konsumenckiego.





LED FLOODLIGHT

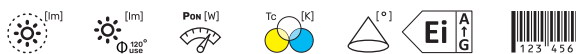

1	VL-F2-305G	VIDEX-FLOOD-LED-DAVIS-30W-NW	3900 lm	3300 lm	30 W	5000K	○	90°	D	4820118299624
2	VL-F2-505G	VIDEX-FLOOD-LED-DAVIS-50W-NW	6500 lm	5500 lm	50 W	5000K	○	90°	D	4820118299631
3	VL-F2-1005G	VIDEX-FLOOD-LED-DAVIS-100W-NW	13000 lm	11000 lm	100 W	5000K	○	90°	D	4820118299648
4	VL-F2-1505G	VIDEX-FLOOD-LED-DAVIS-150W-NW	18000 lm	16500 lm	150 W	5000K	○	90°	D	4820118299907
5	VL-F2-2005G	VIDEX-FLOOD-LED-DAVIS-200W-NW	24000 lm	22000 lm	200 W	5000K	○	90°	D	4820118299921

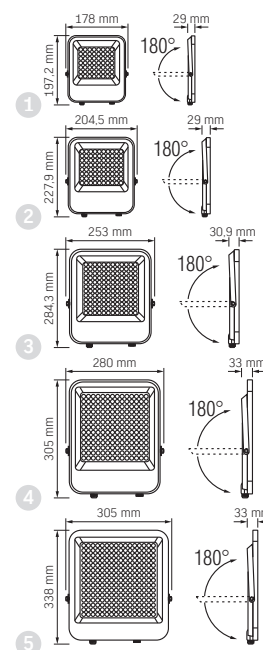

LIGHT INTENSITY CURVES | KRZYWE NATĘŻENIA ŚWIATŁA | The housing material - aluminum | Materiał obudowy - aluminium

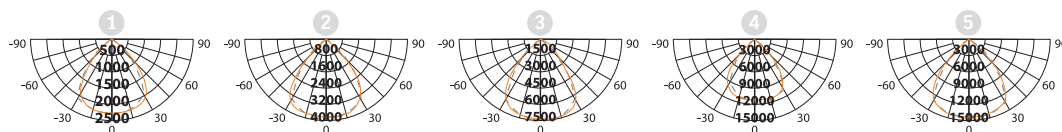

Slim aluminum body, yet highly efficient and capable to operate in volatile mains.
Smukła aluminiowa obudowa, a jednocześnie bardzo wydajna i zdolna do pracy w niestabilnych sieciach elektrycznych.



LED FLOODLIGHT rechargeable battery



VL-F2A-505	1600 lm	50 W	5000K	○	90°	DC 5V, 2A	Li-ion 37 Wh 3.7 V 10000 mAh	4820246482479
------------	---------	------	-------	---	-----	-----------	------------------------------------	---------------

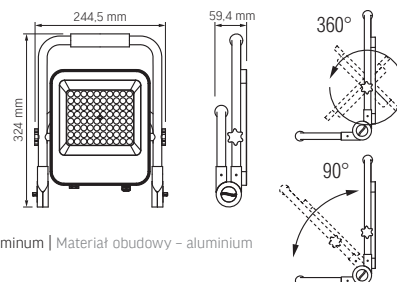

The housing material - aluminum | Materiał obudowy - aluminium

A durable aluminum portable work light with a rechargeable battery, which is equipped with an additional orange signal light. Three brightness modes and a power reserve of up to 12 hours. The case is protected against dust and water.

Wytrzymały aluminiowy przenośny reflektor roboczy z akumulatorem, który wyposażony jest w dodatkową pomarańczową lampę sygnalizacyjną. Trzy tryby jasności i rezerwa mocy do 12 godzin. Obudowa jest zabezpieczona przed kurzem i wodą.



LED FLOODLIGHT

		Φ [lm]	Pow [W]	Tc [K]	Beam [°]	Ei	Barcode	
1	VLE-F2e-105W	VIDEX-FLOOD-LED-LUCA-10W-NW	900 lm	10 W	5000K	90°	F	5904405541098
2	VLE-F2e-205W	VIDEX-FLOOD-LED-LUCA-20W-NW	1800 lm	20 W	5000K	90°	F	5904405541104
3	VLE-F2e-305W	VIDEX-FLOOD-LED-LUCA-50W-NW	2700 lm	30 W	5000K	90°	F	5904405541111
4	VLE-F2e-505W	VIDEX-FLOOD-LED-LUCA-50W-NW	4500 lm	50 W	5000K	90°	F	5904405541128
5	VLE-F2e-1005W	VIDEX-FLOOD-LED-LUCA-100W-NW	9000 lm	100 W	5000K	90°	F	5904405541135

IP65
2 YEARS Warranty

LIGHT INTENSITY CURVES | KRZYWE NATĘŻENIA ŚWIATEŁA | The housing material - aluminum | Materiał obudowy - aluminium

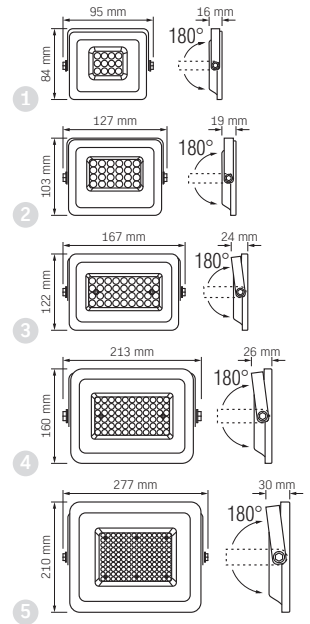
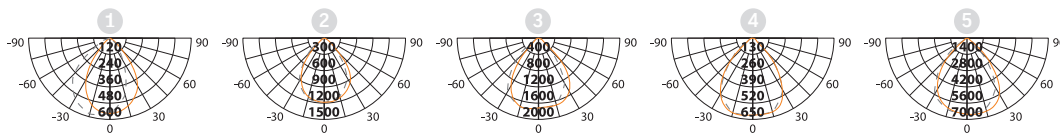

LED FLOODLIGHT with motion detector

		Φ [lm]	Pow [W]	Tc [K]	Beam [°]	Ei	Barcode	
1	VLE-F2e-105W-S	VIDEX-FLOOD-LED-PIR-LUCA-10W-NW	900 lm	10 W	5000K	90°	F	5904405541142
2	VLE-F2e-205W-S	VIDEX-FLOOD-LED-PIR-LUCA-20W-NW	1800 lm	20 W	5000K	90°	F	5904405541159
3	VLE-F2e-305W-S	VIDEX-FLOOD-LED-PIR-LUCA-30W-NW	2700 lm	30 W	5000K	90°	F	5904405541166
4	VLE-F2e-505W-S	VIDEX-FLOOD-LED-PIR-LUCA-50W-NW	4500 lm	50 W	5000K	90°	F	5904405541173

IP65
2 YEARS Warranty

The housing material - aluminum | Materiał obudowy - aluminium

Thermal motion sensor with distance and delay time control after operation. Termiczny czujnik ruchu z regulacją odległości i czasu opóźnienia po uruchomieniu.

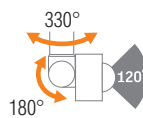
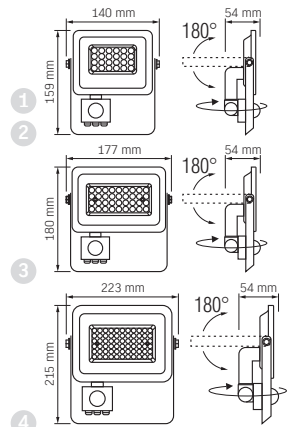
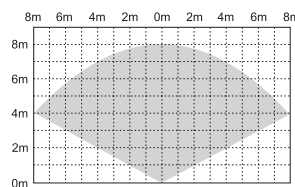

DIAGRAM OF SENSOR COVERAGE SCHEMAT ZASIEGU CZUJNIKA



TIME Time delay after sensor operation **10 s - 7 min**
SENS Sensor detection area **2-8 m**
LUX Light operation threshold **20-1000 Lx**



LED FLOODLIGHT

1	VLE-F3-0105B	VIDEX-FLOOD-LED-F3-10W-5K	950 lm	800 lm	10 W	5000K	110°	F	5904405542422
2	VLE-F3-0205B	VIDEX-FLOOD-LED-F3-20W-5K	1900 lm	1600 lm	20 W	5000K	110°	F	5904405542439
3	VLE-F3-0305B	VIDEX-FLOOD-LED-F3-30W-5K	2850 lm	2400 lm	30 W	5000K	110°	F	5904405542446
4	VLE-F3-0505B	VIDEX-FLOOD-LED-F3-50W-5K	4750 lm	4100 lm	50 W	5000K	110°	F	5904405542453
5	VLE-F3-1005B	VIDEX-FLOOD-LED-F3-100W-5K	9500 lm	8200 lm	100 W	5000K	110°	F	5904405542460

IP65
2 YEARS Warranty

LIGHT INTENSITY CURVES | KRZYWE NATEŻENIA ŚWIATŁA | The housing material - aluminum | Materiał obudowy - aluminium

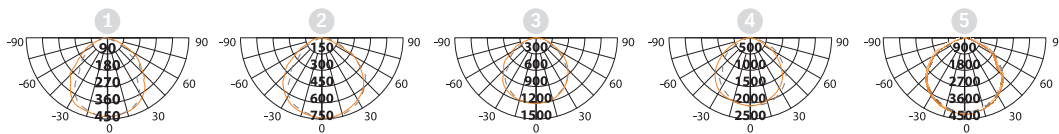

A new spotlight with a special polycarbonate diffuser that evenly distributes the light, making it softer.
 Nowy reflektor ze specjalnym dyfuzorem z poliwęglanu, który równomiernie rozprzodza światło, czyniąc je bardziej miękkim.

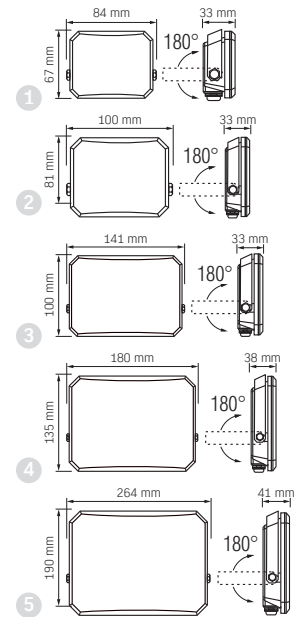

LED FLOODLIGHT with motion detector

1	VLE-F3-0205B-S	VIDEX-FLOOD-LED-F3-PIR-20W-5K	1900 lm	1600 lm	20 W	5000K	110°	F	5904405542477
2	VLE-F3-0305B-S	VIDEX-FLOOD-LED-F3-PIR-30W-5K	2850 lm	2400 lm	30 W	5000K	110°	F	5904405542484
3	VLE-F3-0505B-S	VIDEX-FLOOD-LED-F3-PIR-50W-5K	4750 lm	4100 lm	50 W	5000K	110°	F	5904405542491

IP65
2 YEARS Warranty

DIAGRAM OF SENSOR COVERAGE
SCHEMAT ZASIĘGU CZUJNIKA

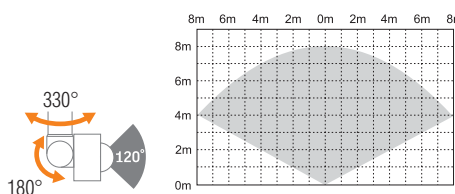

The housing material - aluminum | Materiał obudowy - aluminium

Thermal motion sensor with distance and delay time control after operation.
 Termiczny czujnik ruchu z regulacją odległości i czasu opóźnienia po uruchomieniu.

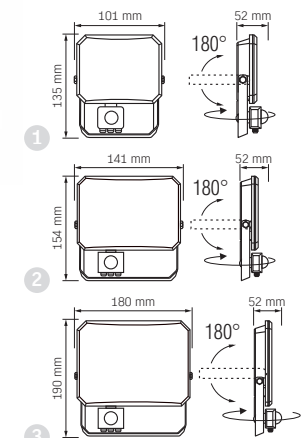

TIME Time delay after sensor operation **10 s - 7 min**
SENS Sensor detection area **2-8 m**
LUX Light operation threshold **10-1000 Lx**



STREET LIGHT



		[lm]	P _{in} [W]	T _c [K]	[°]				
1	VLE-SLe14-305	VIDEX-STREET-LED-LEYA-30W-NW5	2700 lm	30 W	5000K	○	90x130°	F	5904405542286
2	VLE-SLe14-505	VIDEX-STREET-LED-LEYA-50W-NW5	5000 lm	50 W	5000K	○	90x130°	E	5904405542293
3	VLE-SLe14-1005	VIDEX-STREET-LED-LEYA-100W-NW5	10000 lm	100 W	5000K	○	90x130°	E	5904405542279
4	VLE-SLe14-1505	VIDEX-STREET-LED-LEYA-150W-NW5	15000 lm	150 W	5000K	○	90x130°	E	5904405542347

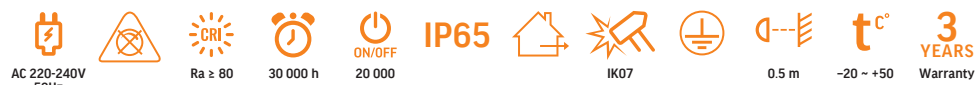

LIGHT INTENSITY CURVES | KRZYWE NATĘŻENIA ŚWIATŁA | The housing material - aluminum | Materiał obudowy - aluminium

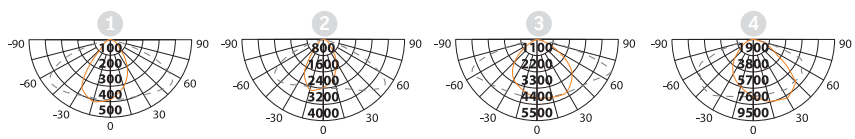

To organize the lighting of platforms, public transport stops, pedestrian streets, sidewalks, impassable parts and squares, streets and roads of local importance.

Do oświetlenia placów, przystanków komunikacji miejskiej, ciągów pieszych, chodników, nieprzejezdnych dróg i placów, ulic i dróg o znaczeniu lokalnym.

For lighting main streets of district importance, main roads and streets of city importance.

Do oświetlenia głównych ulic o znaczeniu powiatowym, głównych dróg i ulic o znaczeniu miejskim.

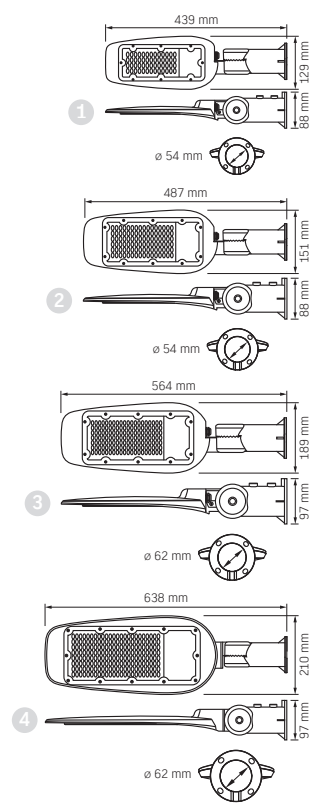



STREET LIGHT

	[lm]	[lm]	[W]	[K]	[°]		
1 VL-SLE17-0305	3300 lm	3000 lm	30 W	5000K	90x130°	E	4820246485579
2 VL-SLE17-0505	5500 lm	5000 lm	50 W	5000K	90x130°	E	4820246485586
3 VL-SLE17-1005	11000 lm	10000 lm	100 W	5000K	90x130°	E	4820246485593

AC 180-265V 50Hz
 Ra ≥ 80
 30 000 h
 ON/OFF 20 000
 IP65

 IK07
 0.5 m
 -30 ~ +50
2 YEARS Warranty

LIGHT INTENSITY CURVES | KRZYWE NATĘŻENIA ŚWIATŁA | The housing material - aluminum | Materiał obudowy - aluminium

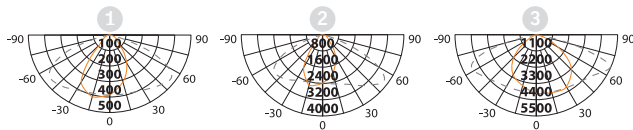

Installation on a pole or on a wall. Adjustable tilt angle of the luminaire. The housing with anti-scratch resistant powder treatment. Montaż na słupie lub na ścianie. Regulowany kąt nachylenia lampy ulicznej. Obudowa pokryta powłoką proszkową odporną na zarysowania.

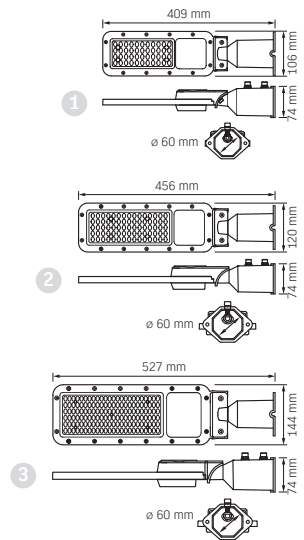

HIGHBAY LIGHT

	[lm]	[lm]	[W]	[K]	[°]		
1 VL-HB01-1005B	18000 lm	15000 lm	100 W	5000K	120°	C	4820246484633
2 VL-HB01-1505B	27000 lm	22400 lm	150 W	5000K	120°	C	4820246484817

AC 100-240V 50Hz
 Ra ≥ 70
 50 000 h
 ON/OFF 20 000
IP65

 0.5 m
 -20 ~ +50
3 YEARS Warranty

The housing material - aluminum | Materiał obudowy - aluminium

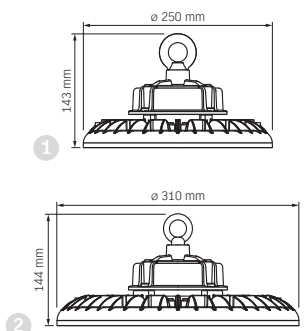

A premium-class highbay light that is characterized by high energy efficiency, the ability to work in a wide range of voltages and a long service life. An irreplaceable solution for warehouses and workshops.

Wysokiej klasy lampa typu highbay charakteryzująca się wysoką energooszczędnością, możliwością pracy w szerokim zakresie napięć oraz długą żywotnością. Niezastąpione rozwiązanie dla magazynów i warsztatów.



LED SOLAR FLOODLIGHT

		[lm]	Tc [K]	[°]			
1	VLE-FSO-205	VIDEX-FLOOD-LED-SOLAR-GELIO-20W-NW	600 lm	5000K ○	90°	LiFePO ₄ 16 Wh 3.2 V 5000 mAh	10 W 6 V 5904405541180
2	VLE-FSO-205-S	VIDEX-FLOOD-LED-SOLAR-GELIO-SENSOR-20W-NW	600 lm	5000K ○	90°	LiFePO ₄ 16 Wh 3.2 V 5000 mAh	10 W 6 V 5904405542354
3	VLE-FSO-1005	VIDEX-FLOOD-LED-SOLAR-GELIO-100W-NW	2800 lm	5000K ○	90°	LiFePO ₄ 96 Wh 3.2 V 30000 mAh	25 W 6 V 5904405541197

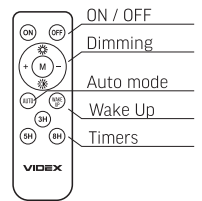

- Power reserve: up to 12 hours
- Full charging cycle: 5-8 hours in sunny weather
- Battery service life: up to 2000 full cycles
- Durable aluminum alloy housing with anti-scratch treatment

- Rezerwa chodu: do 12 godzin
- Pełny cykl ładowania: 5-8 godzin przy słonecznej pogodzie
- Żywotność baterii: do 2000 pełnych cykli
- Trwała obudowa ze stopu aluminium z powłoką odporną na zarysowania

– Microwave motion sensor / Mikrofalowy czujnik ruchu

- Detection distance: up to 8 m
- Detection angle: 180°
- Lighting time after detection: 20/60 s

- Odległość detekcji: do 8 m
- Kąt detekcji: 180°
- Czas świecenia po wykryciu: 20/60 s

LIGHT INTENSITY CURVES | KRZYWE NATĘŻENIA ŚWIATŁA | The housing material - aluminum | Materiał obudowy - aluminium

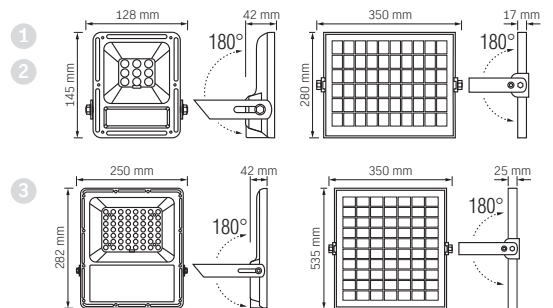
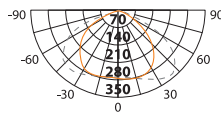
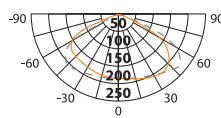

The gold-plated contacts are intended to prevent power loss and improve the overall efficiency of the system during solar energy conversion.

Pozłacane styki zaprojektowano tak, aby zapobiegać utracie mocy i poprawiać ogólną wydajność systemu podczas konwersji energii słonecznej.





LED SOLAR FLOODLIGHT

VL-FS02-505	[lm]	[K]	[°]			
	1000 lm	5000K ○	90°	LiFePO ₄ 32 Wh 3.2 V 10000 mAh	10 W 6 V	4820246482493

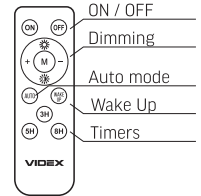

SLIM DESIGN

- Power reserve: up to 12 hours
- Full charging cycle: 5-8 hours in sunny weather
- Battery service life: up to 2000 full cycles
- Durable aluminum alloy housing with anti-scratch treatment

SMUKŁA KONSTRUKCJA

- Rezerwa chodu: do 12 godzin
- Pełny cykl ładowania: 5-8 godzin przy słonecznej pogodzie
- Żywotność baterii: do 2000 pełnych cykli
- Trwała obudowa ze stopu aluminium z powłoką odporną na zarysowania

LIGHT INTENSITY CURVES | KRZYWE NATĘŻENIA ŚWIATŁA

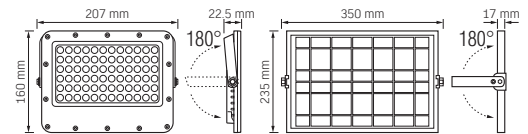
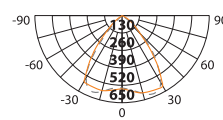

LED SOLAR FLOODLIGHT

VLE-FS03-205	[lm]	[K]	[°]			
VIDEX-FLOOD-LED-SOLAR-HORS-500-NW	500 lm	5000K ○	90°	Li-ion 18.5 Wh 3.7 V 5000 mAh	10 W 6 V	5904405542392

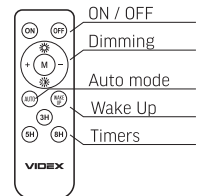

BUILT-IN BATTERY INDICATOR

- Power reserve: up to 12 hours
- Full charging cycle: 5-8 hours in sunny weather
- Battery service life: up to 800 full cycles
- ABS plastic housing with aluminum bracket

WBUDOWANY WSKAŹNIK BATERII

- Rezerwa chodu: do 12 godzin
- Pełny cykl ładowania: 5-8 godzin przy słonecznej pogodzie
- Żywotność baterii: do 800 pełnych cykli
- Obudowa z tworzywa ABS z aluminiowym wspornikiem

LIGHT INTENSITY CURVES | KRZYWE NATĘŻENIA ŚWIATŁA

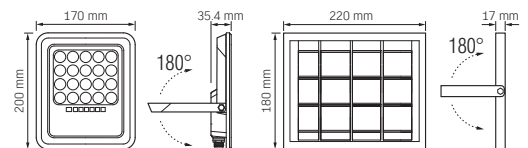
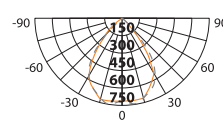



LED SOLAR STREET LIGHT

VLE-SLS0-305	VIDEX-STREET-LED-SOLAR-LANA-100W-NW	2500 lm	5000K	90x130°	LiFePO ₄ 80 Wh 3.2 V 25000 mAh	30 W 6 V	5904405541203

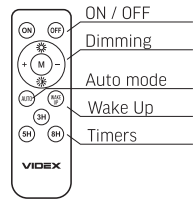

Ra ≥ 80
 30 000 h
 20 000
 IP65

 No Flicker
 IK07
 -20 ~ +50
 0.5 m
 2 YEARS Warranty

- Power reserve: up to 12 hours
- Full charging cycle: 5-8 hours in sunny weather
- Battery service life: up to 2000 full cycles
- Durable aluminum alloy housing
- Recommended mounting height: 3-6 m

LIGHT INTENSITY CURVES | KRZYWE NATĘŻENIA ŚWIATA

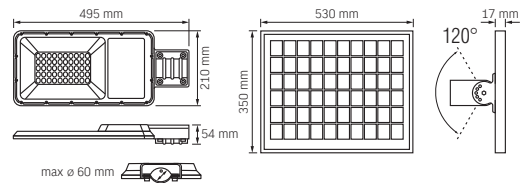
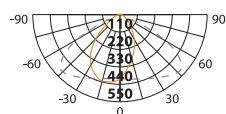

- Rezerwa chodu: do 12 godzin
- Pełny cykl ładowania: 5-8 godzin przy słonecznej pogodzie
- Żywotność baterii: do 2000 pełnych cykli
- Trwała obudowa ze stopu aluminium
- Zalecana wysokość montażu: 3-6 m



LED SOLAR STREET LIGHT microwave motion sensor

VL-SLS0-082-S		2300 lm	5000K	90°	Li-ion 64 Wh 3.2 V 20000 mAh	20 W 6 V	120°	8 m	4820246485920

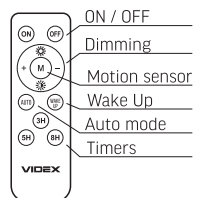

Ra ≥ 80
 25 000 h
 20 000
 IP65

 No Flicker
 IK07
 -20 ~ +50
 0.5 m
 2 YEARS Warranty

- Power reserve: up to 12 hours
- Full charging cycle: 5-8 hours in sunny weather
- Battery service life: up to 2000 full cycles
- Durable aluminum alloy housing with anti-scratch treatment
- Recommended mounting height: 4-6 m

LIGHT INTENSITY CURVES | KRZYWE NATĘŻENIA ŚWIATA

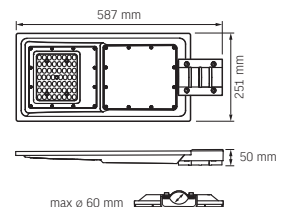
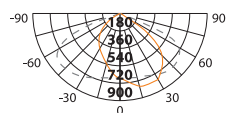

- Rezerwa chodu: do 12 godzin
- Pełny cykl ładowania: 5-8 godzin przy słonecznej pogodzie
- Żywotność baterii: do 2000 pełnych cykli
- Trwała obudowa ze stopu aluminium z powłoką odporną na zarysowania
- Zalecana wysokość montażu: 4-6 m



LED SOLAR PARK LIGHT with motion sensor



VL-GLSO-1254-S

1400 lm 5000K 60° LiFePO₄ 38.4 Wh 3.2 V 12000 mAh 15 W 5 V 120° 12 m 4820246484329

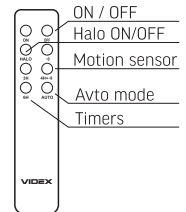

DECORATIVE HALO STANDBY LIGHT

- Power reserve: up to 14 hours
- Full charging cycle: 4-6 hours in sunny weather
- Battery service life: up to 2000 full cycles
- ABS plastic housing
- Recommended mounting height: 3-6 m

DEKORACYJNE ŚWIATŁO GOTOWOŚCI TYPU HALO

- Rezerwa chodu: do 14 godzin
- Pełny cykl ładowania: 4-6 godzin przy słonecznej pogodzie
- Żywotność baterii: do 2000 pełnych cykli
- Obudowa z tworzywa ABS
- Zalecana wysokość montażu: 3-6 m

LIGHT INTENSITY CURVES | KRZYWE NATĘŻENIA ŚWIATŁA

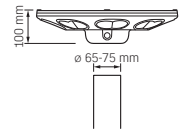
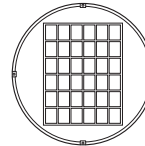
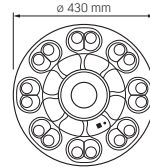
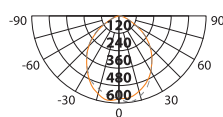

LED SOLAR WALL LIGHT with motion sensor



VL-WLSO-025-S

600 lm 5000K 60° LiFePO₄ 6.4 Wh 3.2 V 2000 mAh 2 W 5 V 120° 12 m 4820246484312



Rotating lighting part. The device has two ways of use:

- for standard outdoor lighting using a motion sensor
- for illuminating walls or other architectural objects without using a motion sensor

Obrotowa część oświetleniowa. Urządzenie ma dwa sposoby użycia:

- do standardowego oświetlenia zewnętrznego za pomocą czujnika ruchu
- do oświetlania ścian lub innych obiektów architektonicznych bez zastosowania czujnika ruchu

- Power reserve: up to 12 hours
- Full charging cycle: 4-6 hours in sunny weather
- Battery service life: up to 2000 full cycles
- ABS plastic housing

- Rezerwa chodu: do 12 godzin
- Pełny cykl ładowania: 4-6 godzin przy słonecznej pogodzie
- Żywotność baterii: do 2000 pełnych cykli
- Obudowa z tworzywa ABS

LIGHT INTENSITY CURVES | KRZYWE NATĘŻENIA ŚWIATŁA

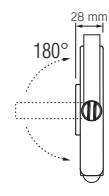
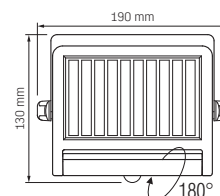
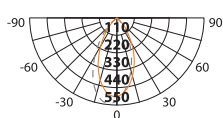

PORTABLE SOLAR CHARGING PANELS

Ultra-slim design flexible solar charging panels are highly portable due to its low profile and light weight. New generation mono crystalline photo cell ensures maximum efficiency of solar energy conversion to charge your mobile device. Integral body construction made with durable polymer material, scratch and wear resistant with high light transparence index. Perfect mate for those like outdoor tourism.

PRZENOŚNE PANELE ŁADOWANIA SŁONECZNEGO

Elastyczne panele słoneczne o wyjątkowo cienkiej konstrukcji są bardzo przenośne ze względu na niski profil i niewielką wagę. Fotokomórka monokrystaliczna nowej generacji zapewnia maksymalną efektywność konwersji energii słonecznej do ładowania urządzenia mobilnego. Zintegrowana konstrukcja korpusu wykonana z trwałego materiału polimerowego, odpornego na zarysowania i zużycie, o wysokim wskaźniku przezroczystości światła. Idealny towarzysz dla miłośników turystyki na świeżym powietrzu.



Wear-resistant housing coating.
Odporna na zużycie powłoka obudowy.

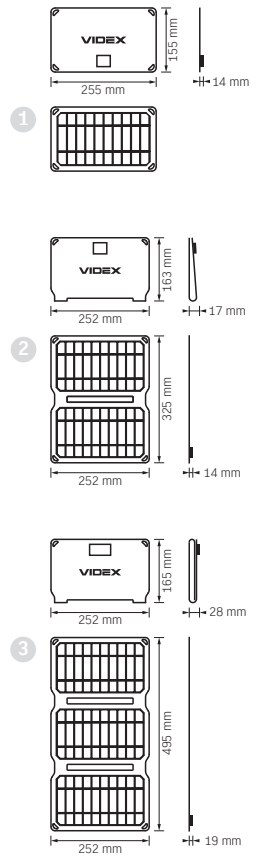

SOLAR PANEL portable



	5 W	max: 1 A 6 V	output: USB x1	4820246483520
1 VSO-F505U	10 W	max: 2 A 6 V	output: USB x1	4820246483537
2 VSO-F510U	15 W	max: 3 A 6 V	output: USB x2	4820246483544
3 VSO-F515UU				

IP68 **2 YEARS** Warranty



The manufacturer reserves the right to make technical changes. The data contained in this material is not legally binding.

Producent zastrzega sobie prawo do zmian technicznych. Dane zawarte w niniejszym materiale nie są prawnie wiążące.

Allegro opt is the right holder of the registered trademark «VIDEX». All rights reserved.

Allegro opt jest właścicielem praw autorskich do zarejestrowanego znaku towarowego «VIDEX». Wszelkie prawa zastrzeżone.



Allegro opt PE
106-G Heroiv Mariupolia str.,
Kropyvnytskyi, 25004, Ukraine

tel. +38 0522 245 377
info@videx.ua

www.videx.ua

Allegro opt Sp. z o.o.
Mierzeja Wiślana 11,
Krakow, 30-732, Poland

tel. +48 531 880 871
biuro@videx.com.pl

www.videx.com.pl